

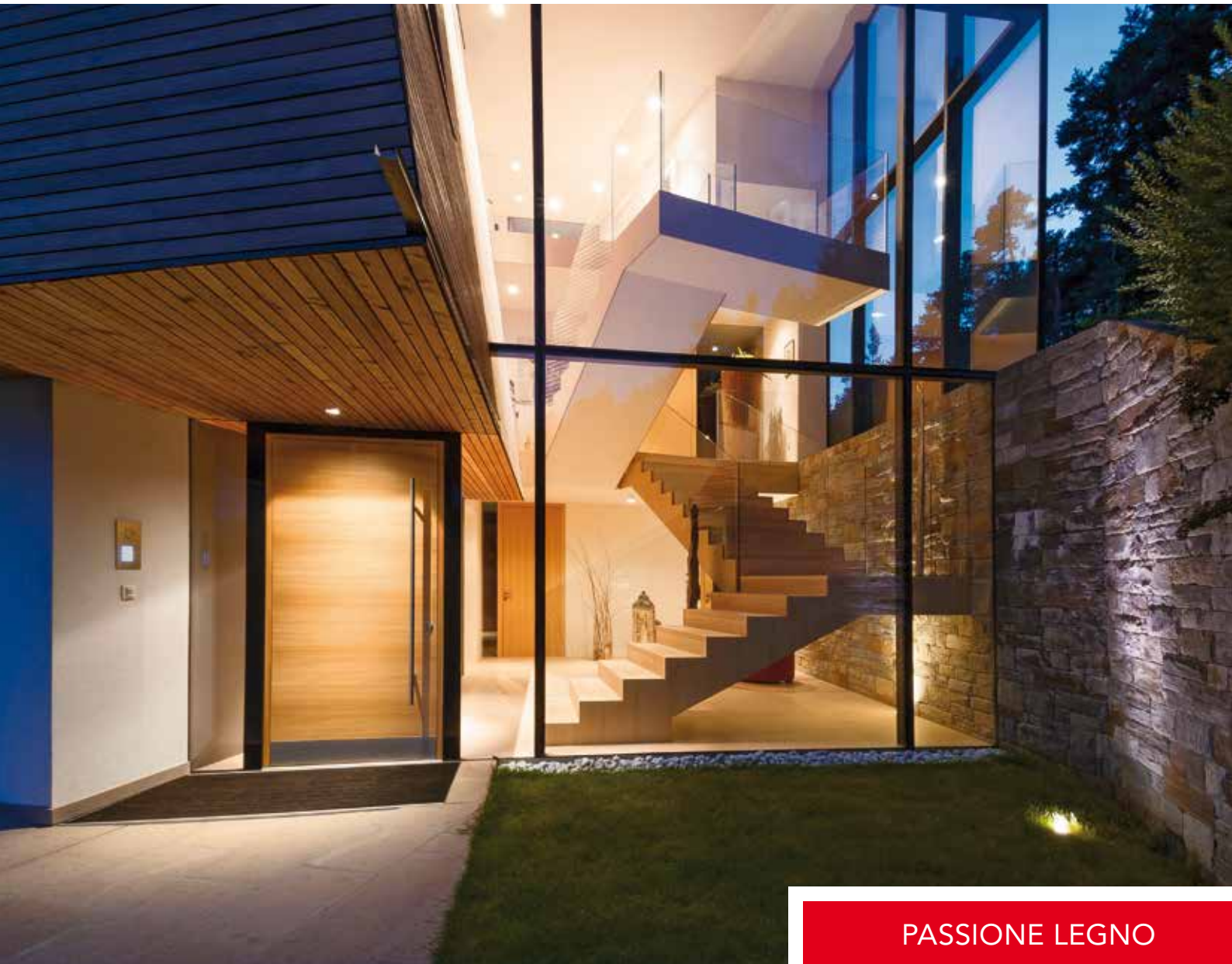













PORTONCINI DESIGN
FRONT DOORS DESIGN



PIANIFICARE, PROGETTARE, COSTRUIRE, RISANARE, RISTRUTTURARE, ARREDARE ... CON I PORTONCINI RUBNER.

Ci siamo posti l'obiettivo di realizzare uno strumento completo di aiuto alla progettazione per architetti, progettisti, falegnami, rivenditori specializzati e imprese edili che tratti in dettaglio il tema dei portoncini. Richiedete una consulenza specializzata per scegliere il portoncino in legno che meglio risponde alle vostre esigenze.

	<p>SYSTEM ECO100® Sostenibile, in legno e sughero <i>Sustainable, in wood and cork</i></p> <p>4</p>		<p>Portoncini tradizionali CasaClima <i>ClimateHouse traditional front doors</i></p> <p>48</p>
	<p>Dal Sud dell'Italia al Nord della Germania <i>From Southern Italy to Northern Germany</i></p> <p>6</p>		<p>LEGNO VECCHIO Portoncini CasaClima <i>OLD WOOD ClimateHouse front doors</i></p> <p>60</p>
	<p>Nate in Alto Adige ... <i>Born in South Tyrol ...</i></p> <p>8</p>		<p>Tutela storico-artistica Portoncini CasaClima <i>Historic-artistic protection ClimateHouse front doors</i></p> <p>72</p>
	<p>Portoncini CasaClima Rubner nel mondo <i>ClimateHouse front doors around the world</i></p> <p>10</p>		<p>PROTECTA® – all'esterno Max-Exterior all'interno legno <i>Max-Exterior outside wood inside</i></p> <p>82</p>
	<p>Portoncini moderni CasaClima <i>ClimateHouse modern front doors</i></p> <p>24</p>		<p>Portali stravaganti <i>Extravagant portals</i></p> <p>94</p>
	<p>Portoncini CasaClima a filo <i>ClimateHouse flush front doors</i></p> <p>40</p>		<p>Risanamento – il vecchio diventa nuovo <i>Redevelopment – from old to new</i></p> <p>100</p>
	<p>Sopraluci ed elementi laterali <i>Transom windows and side elements</i></p> <p>46</p>		<p>Prima – dopo</p> <p>104</p>

**PLAN, DESIGN, BUILD, REDEVELOP,
RENOVATE, FURNISH ...
WITH RUBNER FRONT DOORS.**

The goal we have set ourselves is to create a complete tool that can aid the designing work of architects, designers, carpenters, special dealers and construction companies that actively deal in front doors. Ask one of our specialised consultants to help you find the wooden front door that is best for you.

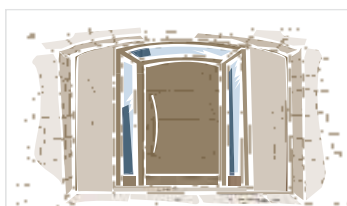

**Esterno e interno –
soluzioni individuali**
*Outside and inside –
individual
solutions*

108



**Maniglioni, maniglie,
zoccoli in lamiera**
*Push handles, handles,
kick plates*

132



**Perchè i portoncini Rubner
sono i migliori**
*Why Rubner front doors
are the best*

114



Accessori esclusivi
Exclusive accessories

136



Elevata protezione
Well protected

116



**Oltre 30 anni
di successo**

138

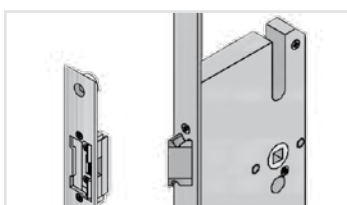

Chiusura multipunto
Multipoint lock

120



**Le quattro sedi
di Rubner Porte**

140



**Portoncini di sicurezza
per la Svizzera**
*Security front doors
for Switzerland*

122



**Tutto da un
unico fornitore**
*All from the
same supplier*

142



**Sistemi di chiusura
elettronici**
*Electronic locking
systems*

125



**Mondo delle
porte Rubner**
Rubner doors' world

144



**Progettare con
legno, colore e vetro**
*Designing with wood,
colour and glass*

128



**Passione legno
Gruppo Rubner**
*Passion for wood
Rubner Group*

146

MATERIA PRIMA ECOLOGICA LEGNO
WOOD – AN ENVIRONMENT-
FRIENDLY RAW MATERIAL



**TUTTI I PORTONCINI
RUBNER SONO
PRODOTTI CON
IL SISTEMA **ECO 100**[®]
SOSTENIBILE,
IN LEGNO
E SUGHERO.**

**ALL RUBNER
FRONT DOORS
ARE MANUFACTURED
IN WOOD AND CORK
ACCORDING TO
THE **ECO 100**[®]
SUSTAINABLE SYSTEM.**

Il legno – materia prima rinnovabile

Il prezioso habitat naturale rappresentato dalla foresta fornisce una materia prima rinnovabile ed ecologica: il legno. Grazie al suo carattere naturale e alle proprietà che garantiscono un ambiente abitativo sano e duraturo, il legno è un materiale moderno con il quale Rubner da decenni si dedica allo sviluppo e alla produzione di portoncini.

RUBNER PORTE ha sviluppato una nuova porta ecologica per CasaClima

ECO 100[®] – nata dalla combinazione di due materiali naturali, il legno e il sughero. Il sughero è un isolante eccezionale dotato di ottime caratteristiche:

- ottimo isolante termico
- insonorizzante
- energetico
- impermeabile ai liquidi
- robusto e indeformabile
- ignifugo
- traspirante
- riflette la temperatura ambientale
- antistatico (non attira la polvere)
- rinnovabile
- è un prodotto locale
- riciclabile

Wood – a renewable raw material

The forest is a natural habitat that provides us with a renewable and environment-friendly resource: wood. Because it is natural and has special properties capable of guaranteeing a healthy and long-lasting dwelling environment, wood is a modern material that Rubner has been employing for decades in the development and manufacture of its front doors.

RUBNER DOORS has developed a new ecological door for ClimateHouse

ECO 100[®] – born of the combination of two natural materials, wood and cork. Cork is an exceptional insulating material with excellent characteristics:

- very good heat insulation
- sound proofing
- energetic
- impermeable to liquids
- robust and indeformable
- fire-resistant
- transpirant
- reflects ambient temperature
- antistatic (does not attract dust)
- renewable
- a local product
- recyclable



LE PORTE RUBNER SONO DI CASA DALL'ITALIA DEL SUD ALLA GERMANIA DEL NORD.

Processi produttivi innovativi, procedure di test continue, innovazioni tecniche costanti accompagnate da un'esperienza ultra-trentennale nella produzione di portoncini in legno sono gli elementi che assicurano una qualità elevata e costante. Ciò significa che i **portoncini CasaClima ECO100® di Rubner**, con la loro altissima stabilità, rientrano nella classe dei migliori anche in presenza di condizioni meteorologiche estreme. E non è un caso se, da Palermo ad Amburgo, abbiamo clienti soddisfatti delle porte Rubner.

RUBNER DOORS WELCOME PEOPLE HOME FROM SOUTHERN ITALY TO NORTHERN GERMANY.

*Innovative production processes, continuous test procedures, constant technical innovation accompanied by over thirty years of experience in the manufacture of wooden front doors are all elements that guarantee very high and constant quality. This means that the **ClimateHouse ECO100® front doors by Rubner**, with their very high standards of stability, are at the top of the list even where weather conditions are extreme. It's not just a coincidence that from Palermo to Hamburg clients are fully satisfied with their Rubner doors.*



Marcatura CE secondo la norma EN 14351-1 : 2006.

I certificati di idoneità per varie classi climatiche e per diversi tipi di sollecitazione attestano l'elevato livello di ermeticità, di resistenza alla pioggia battente, di protezione antieffrazione, di isolamento acustico e di protezione antincendio, oltre alle eccezionali caratteristiche di isolamento termico contro il caldo e il freddo e di ottima tenuta all'aria.



CE marking according to EN 14351-1 : 2006 standard.

The certificates of suitability obtained for various climate classes and various types of stress stand for the high levels of tightness and resistance to rain penetration, as well as for the burglar-proofing, sound-proofing and fire resistance characteristics of our doors, as well as for their exceptional insulation characteristics against cold and heat.

ITALIA MERIDIONALE / SOUTHERN ITALY

Clima caldo e asciutto – temperatura: 41°C

Hot and dry climate – temperature: 41°C



ALPI / ALPS

Freddo, neve e ghiaccio – temperatura: -29°C

Cold, snow and ice – temperature: -29°C



GERMANIA SETTENTRIONALE / NORTHERN GERMANY

Pioggia e nebbia – umidità relativa: 87%

Rain and fog – relative humidity: 87%



NATE IN ALTO ADIGE ... BORN IN SOUTH TYROL ...



Monte di Mezzo sull'altopiano
del Renon, sullo sfondo
il massiccio dello Sciliar

*Monte di Mezzo on the
Renon plateau, with the Sciliar
massif in the background*

**PER AFFERMARSI
NEL MONDO INTERO.**

**ACCLAIMED
THROUGHOUT THE WORLD.**

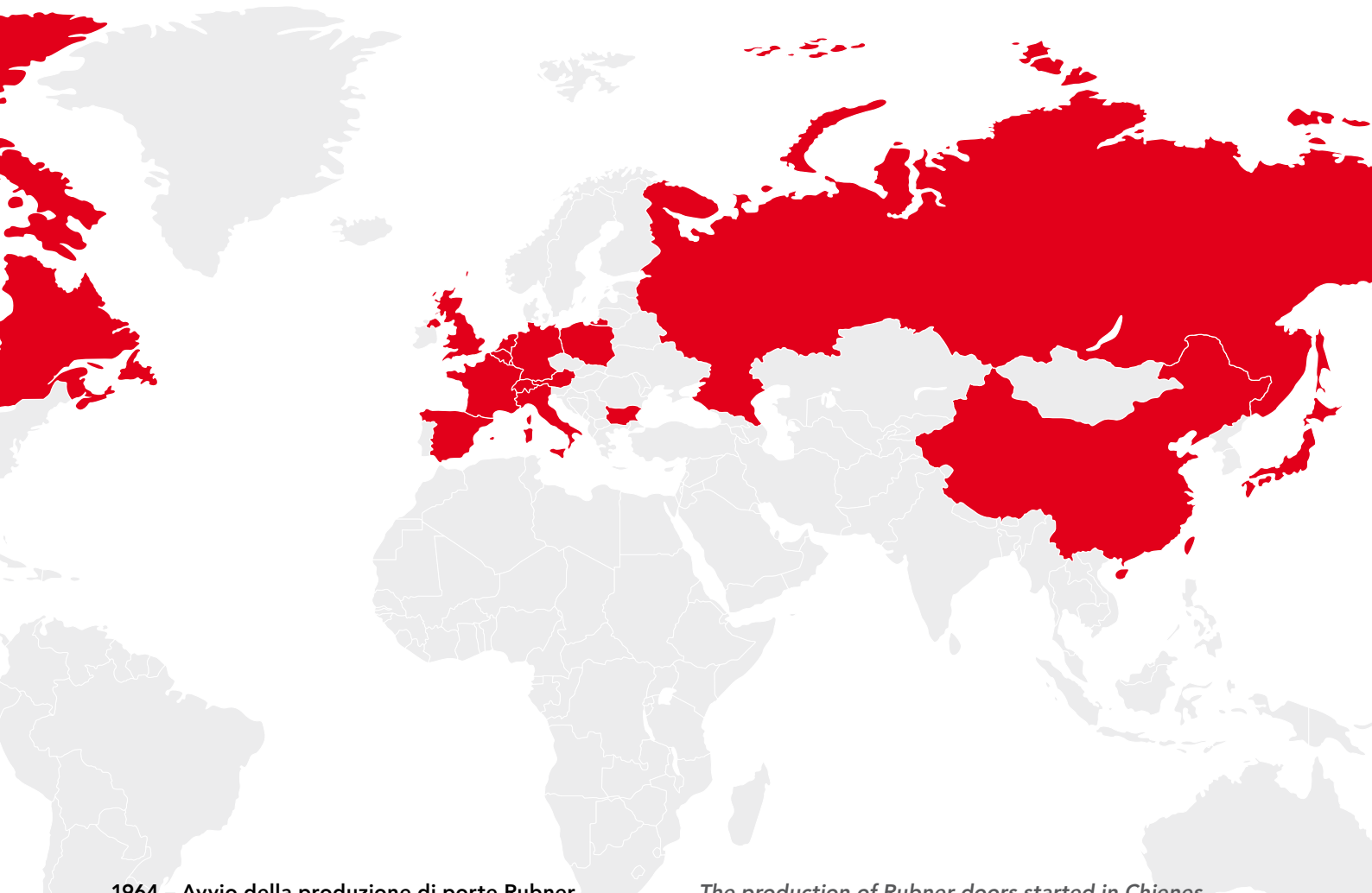

1964 – Avvio della produzione di porte Rubner a Chienes.

Da oltre tre generazioni RUBNER trasforma idee straordinarie in un immenso mondo di prodotti in legno.

Grazie ad una spiccata sensibilità, il connubio tra l'uomo, la tecnologia e la natura ha permesso di dare vita ad un vastissimo assortimento di porte in legno per esterni ed interni.

Oggi – ogni anno 4500 portoncini raggiungono i quattro angoli del globo.

I portoncini Rubner garantiscono solida eleganza. Materiali, colori e forme si sposano con la qualità in un'opera realizzata su misura, che tiene conto dei desideri individuali. Il cliente riceve un pezzo unico di massimo livello qualitativo. Forte di ormai 190 dipendenti, Rubner Türen S.p.A. è oggi uno specialista affermato sui mercati internazionali nel campo delle porte in legno pregiate. I suoi clienti si trovano in Italia, Austria, Svizzera, Liechtenstein, Germania, Gran Bretagna, Francia, Spagna, Bulgaria, Belgio, Lussemburgo, Polonia, Russia, Cina, Giappone e Canada.

The production of Rubner doors started in Chienes as far back as 1964.

For over three generations RUBNER has been transforming extraordinary ideas into an immense world of wood products. Thanks to our high degree of sensitivity, the match between man, technology and nature has given birth to a truly vast assortment of interior and exterior wood doors.

Today – every year, 4500 front doors reach the four corners of the earth.

Rubner front doors are a guarantee of solid elegance. Materials, colours and shapes combine with quality in artefacts made to measure and tailored on the individual needs of our clients, who receive a unique piece of the highest quality. With a powerful workforce of 190 employees, Rubner Türen S.p.A. today is a top ranking specialist throughout the world in the field of top-class wood doors. Clients are opening our doors in Italy, Austria, Switzerland, Liechtenstein, Germany, Great Britain, France, Spain, Bulgaria, Belgium, Luxembourg, Poland, Russia, China, Japan and Canada.

**PORTONCINO CASACLIMA
IN ALTO ADIGE**



Portoncino liscio a filo, integrato nella facciata / *Smooth, flush front door cohesive with the facade*

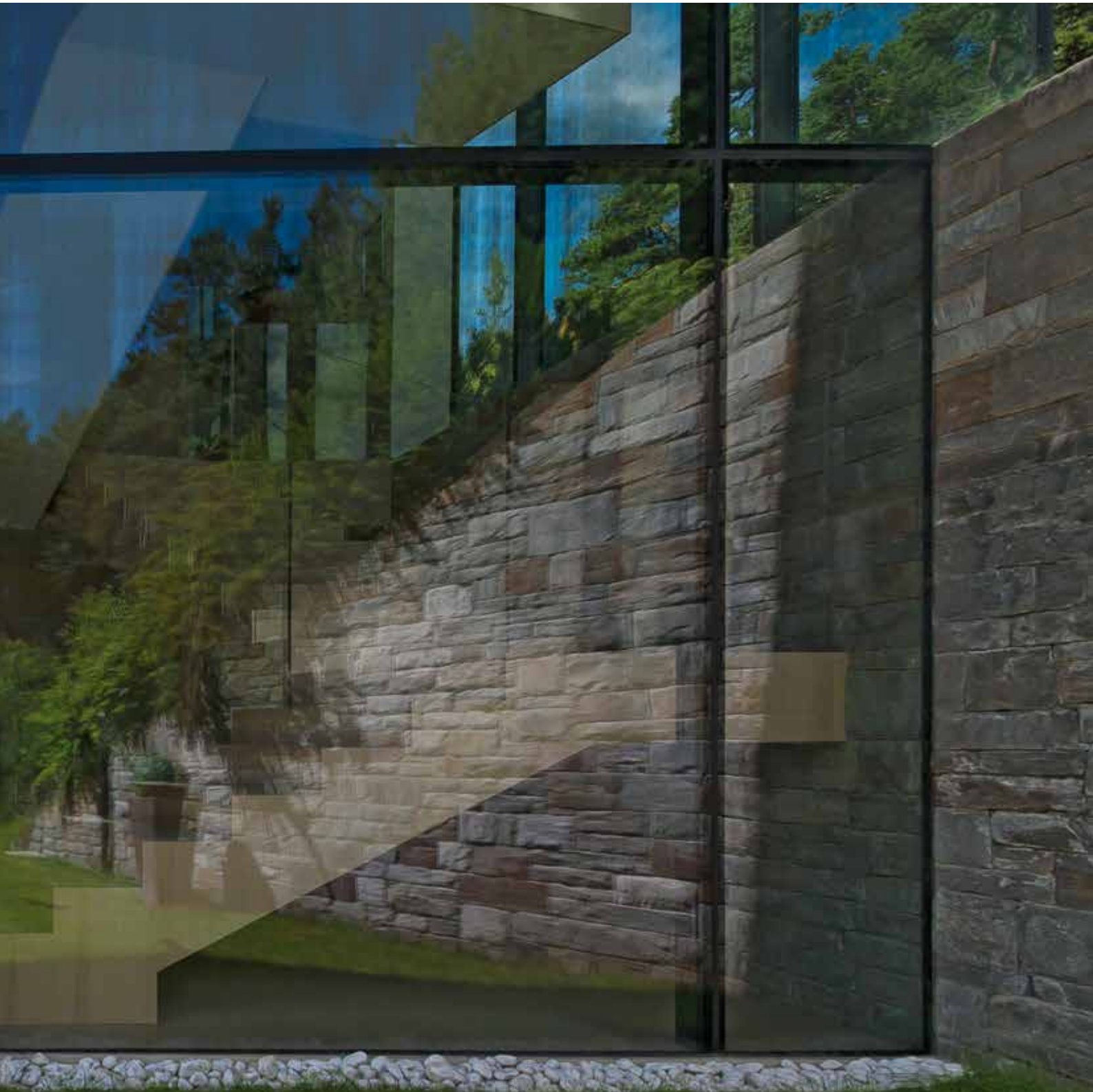

**CLIMATEHOUSE FRONT DOOR
IN SOUTH TYROL**

PORTONCINO CASACLIMA IN GERMANIA



Portoncino modello H131 con elemento laterale S1 su entrambi i lati / *Front door model H131 with side element S1 on both sides*



**CLIMATEHOUSE FRONT DOOR
IN GERMANY**

PORTONCINO CONFORME ALLO STANDARD MINERGIE IN SVIZZERA





**FRONT DOOR COMPLIANT WITH
THE MINERGIE STANDARD IN SWITZERLAND**

PORTONCINO CASA CLIMA IN AUSTRIA



Portoncino a filo, ricoperto all'esterno con assi in legno massiccio in Tirolo del Nord

Flush front door, external face lined with solid wood boards in North Tyrol



**CLIMATEHOUSE FRONT DOOR
IN AUSTRIA**

PORTONCINO CASACLIMA IN ITALIA





**CLIMATEHOUSE FRONT DOOR
IN ITALY**

**PORTONCINI CASACLIMA
NEL MONDO**



Portoncino ad arco a due ante in Spagna meridionale / *Arched double front door in Southern Spain*



**CLIMATEHOUSE FRONT DOORS
AROUND THE WORLD**



Portoncino modello H21 con
elemento laterale su entrambi
i lati in Bulgaria

*Front door model H21 with
side element on both sides in
Bulgaria*



Portoncino con rivestimento in bronzo sul lato esterno a San Tropez
Front door with bronze finish on the outside in Saint Tropez

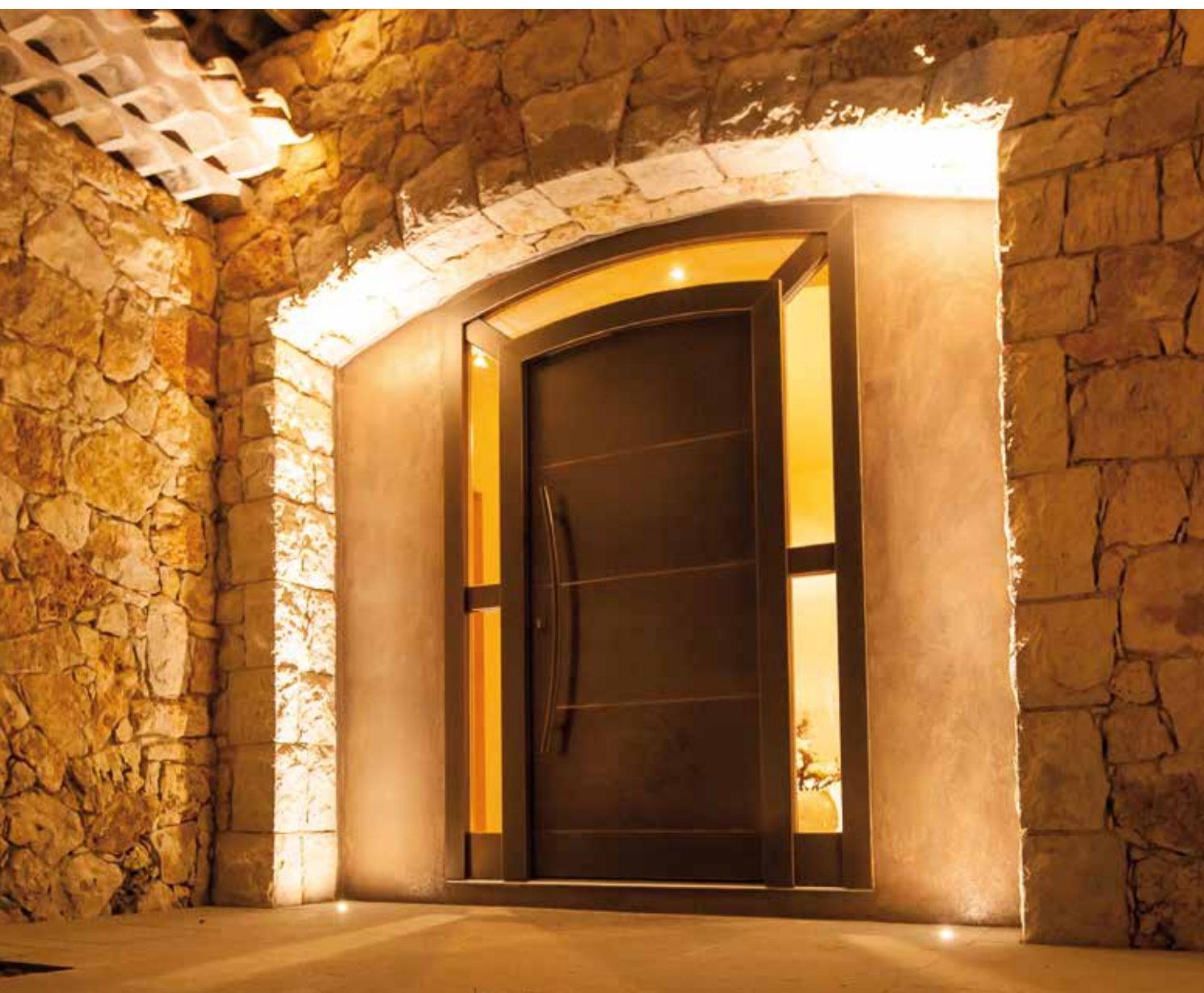



Giappone, portoncino modello H52 presso Tokyo

Japan, front door model H52 near Tokyo



Portoncino modello H47 con elemento laterale S47 a Mosca

Front door model H47 with side element S47 in Moscow



DESIGN MODERNO
MODERN DESIGN





PORTONCINI ESCLUSIVI CASA CLIMA **ECO 100**[®]
EXCLUSIVE CLIMATEHOUSE **ECO 100**[®] FRONT DOORS





- 1 Modello speciale con lamiera nera in Austria
- 2 Portoncino liscio con fresature a V ed elemento laterale S6 presso Merano - Alto Adige
- 3 Portoncino modello H106 in Alto Adige
- 4 Portoncino modello H124 con elemento laterale S1 a Stoccarda - Germania

- 1 *Special model with black steel in Austria*
- 2 *Smooth front door with V-joints and side element S6, near Merano - South Tyrol*
- 3 *Front door model H106 in South Tyrol*
- 4 *Front door model H124 with side element S1 in Stuttgart - Germany*

2



3



4



1

- 1 Portoncino liscio con strisce in acciaio inox ed elemento laterale S1 in Alto Adige
- 2 Portoncino con strisce decorative ed elemento laterale S1 in Alto Adige
- 3 Portoncino modello H106 a Bolzano - Alto Adige
- 4 Portoncino liscio con elemento laterale S1, Stiria - Austria
- 5 Portoncino modello H137 in Val Gardena - Alto Adige, superficie in rovere a spacco, telaio RAL 8019



2



3



4

- 1 Smooth front door with stainless steel stripes and side element S1 in South Tyrol
- 2 Front door with decorative stripes and side element S1 in South Tyrol
- 3 Front door model H106 in Bolzano - South Tyrol
- 4 Smooth front door with side element S1 in Styria - Austria
- 5 Front door model H137 in Val Gardena - South Tyrol, chopped oak surface, frame RAL 8019



5





2

- 1 Portoncino a filo con vetro smaltato a Zermatt - Svizzera
- 2 Portoncino liscio con applicazioni in acciaio inox in Alto Adige
- 3 Modello speciale con fresature a V ed elemento laterale S1 a Rosenheim - Germania

- 1 *Flush front door with enamelled glass in Zermatt - Switzerland*
- 2 *Smooth front door with stainless steel applications in South Tyrol*
- 3 *Special model with V-joints and side element S1 in Rosenheim - Germany*



3



1

- 1 Portoncino modello H106 con elemento laterale S6 in Alto Adige
- 2 Modello speciale con sopra luce nella regione del Baden Württemberg - Germania
- 3 Portoncino modello H94 nell'Allgäu - Germania
- 4 Portoncino liscio con vetro smaltato a Terlano - Alto Adige
- 5 Modello speciale a Barbiano - Alto Adige
- 6 Portoncino nel Trentino - Italia

- 1 *Front door model H106 with side element S6 in South Tyrol*
- 2 *Special model with transom window in Baden-Württemberg - Germany*
- 3 *Front door model H94 in Allgäu - Germany*
- 4 *Smooth front door with enamelled glass in Terlano - South Tyrol*
- 5 *Special model in Barbiano - South Tyrol*
- 6 *Front door in Trentino - Italy*

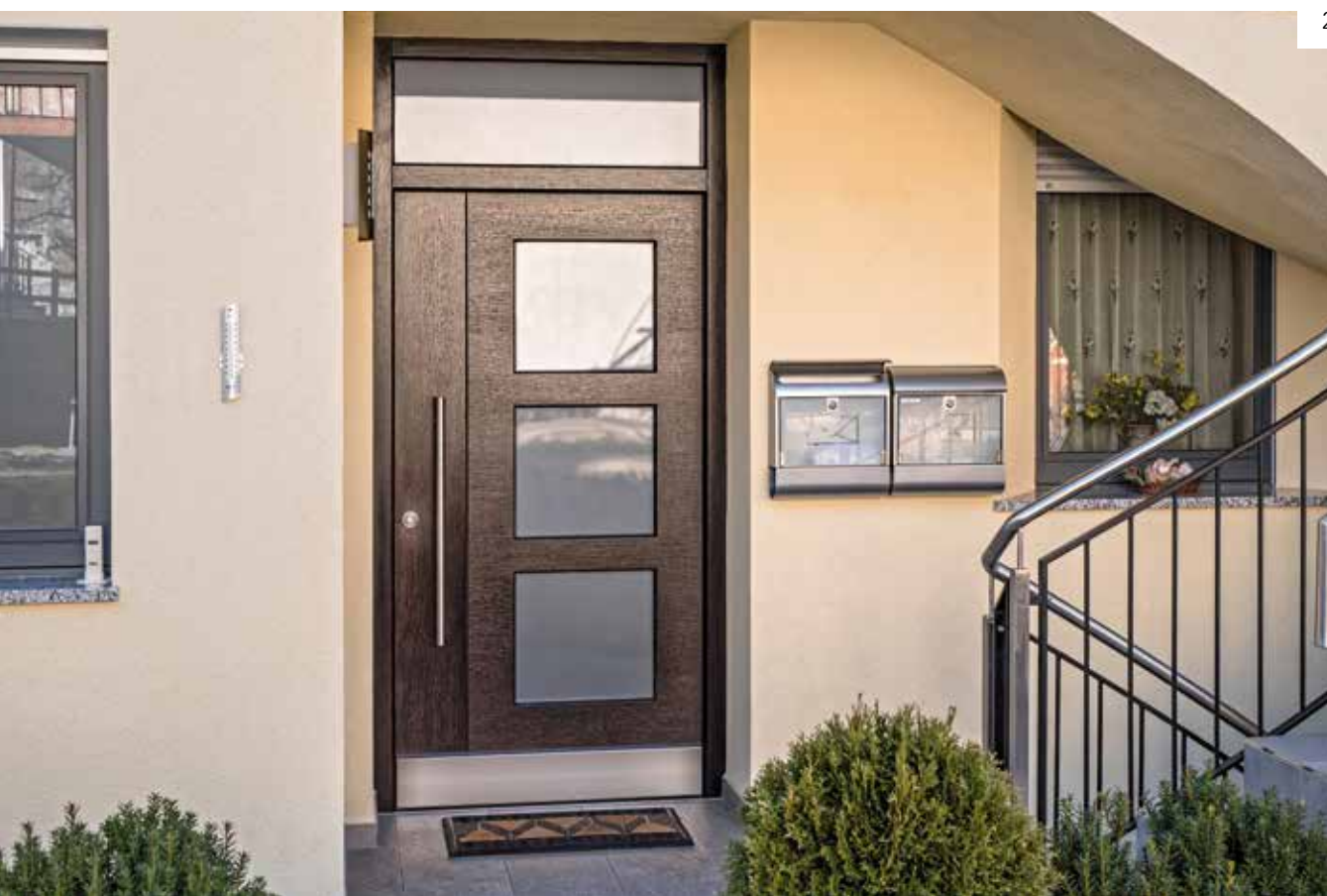

2



3

4

5

6



1

- 1 Portoncino modello H91 senza fresature a V a Vipiteno - Alto Adige
- 2 Portoncino modello H108 con elemento laterale S1 presso Stoccarda - Germania
- 3 Modello speciale a Padova - Italia
- 4 Portoncino liscio con fresature a V a Rosenheim
- 5 Portoncino modello H108 con sopraluce, Renon - Alto Adige

- 1 *Front door model H91 without V-joints in Vipiteno - South Tyrol*
- 2 *Front door model H108 with side element S1, near Stuttgart - Germany*
- 3 *Special model in Padova - Italy*
- 4 *Smooth front door with V-joints in Rosenheim*
- 5 *Front door model H108 with transom window, Renon - South Tyrol*



2



3



4



5



1



2

- 1 Portoncino modello H131 con elemento laterale S1 in Val Sarentino - Alto Adige
- 2 Portoncino a filo in Val Pusteria - Alto Adige
- 3 Portoncino liscio con impiallacciatura a piano di sega in Tirolo Orientale - Austria

- 1 *Front door model H131 with side element S1 in Val Sarentino - South Tyrol*
- 2 *Flush front door in Val Pusteria - South Tyrol*
- 3 *Smooth front door with sawn finish veneering in East Tyrol - Austria*



3

- 1 Portoncino liscio con elemento laterale S1 in larice con nodi vicino a Vienna - Austria
- 2 Modello speciale con vetro smaltato a Livigno - Italia
- 3 Soluzione completa, portoncino modello H131 con elemento laterale S1 presso Stoccarda - Germania
- 4 Portoncino modello H108 con elemento laterale S1 a Landshut - Baviera



1



2



- 1 Smooth front door with side element S1 in larch knotty, near Vienna - Austria
- 2 Special model with enamelled glass in Livigno - Italy
- 3 Complete solution, front door model H131 with side element S1, near Stuttgart - Germany
- 4 Front door model H108 with side element S1 in Landshut - Bavaria



PORTONCINI A FILO CASACLIMA ECO100®

Le caratteristiche di un portoncino Rubner a filo CasaClima ECO100®:

- Barriera alu-fenolica antievaporazione su entrambi i lati
- Sistema di serratura a più punti di chiusura e frontale passante
- Impiego di cerniere di elevata qualità in acciaio inox, a tre perni registrabili
- A scelta vetro isolante inserito a filo sul lato esterno e fermavetro a filo sul lato interno



FLUSH CLIMATEHOUSE ECO 100® FRONT DOORS

The characteristics of a Rubner flush ClimateHouse ECO 100® front door:

- Aluminium and phenol vapour barrier
- Locking system with multiple locking points and long forend
- High quality stainless steel hinges with three adjustable pins
- On request, insulating glass pane mounted flush on the outside and flush glass stop on the inside



Portoncino a filo,
ricoperto all'esterno con
assi in legno massiccio
in Alto Adige

Flush front door,
external face lined with
solid wood boards
in South Tyrol

- 1 Portoncino liscio a filo con elemento laterale con vetro smaltato nella regione del Baden-Württemberg - Germania
 - 2 Portoncino a filo con inserto con vetro smaltato vicino a Zurigo - Svizzera
 - 3 Modello speciale in Val Venosta - Alto Adige
-
- 1 *Smooth, flush front door with side element in enamelled glass in Baden-Württemberg - Germany*
 - 2 *Flush front door with glass insert in enamelled glass, near Zurich - Switzerland*
 - 3 *Special model in Val Venosta - South Tyrol*





2



3



1



2



3

- 1 Modello speciale, portoncino a filo, Baden-Württemberg - Germania
- 2 Portoncino a filo con elemento laterale S1 su entrambi i lati a Vienna - Austria
- 3 Portoncino a filo con elemento laterale S1 a S. Gallo - Svizzera
- 4 Portoncino a filo in Val Venosta - Alto Adige

- 1 *Special model, flush front door in Baden-Württemberg - Germany*
- 2 *Flush front door with side element S1 on both sides in Vienna - Austria*
- 3 *Flush front door with side element S1 in St. Gallen - Switzerland*
- 4 *Flush front door in Val Venosta - South Tyrol*

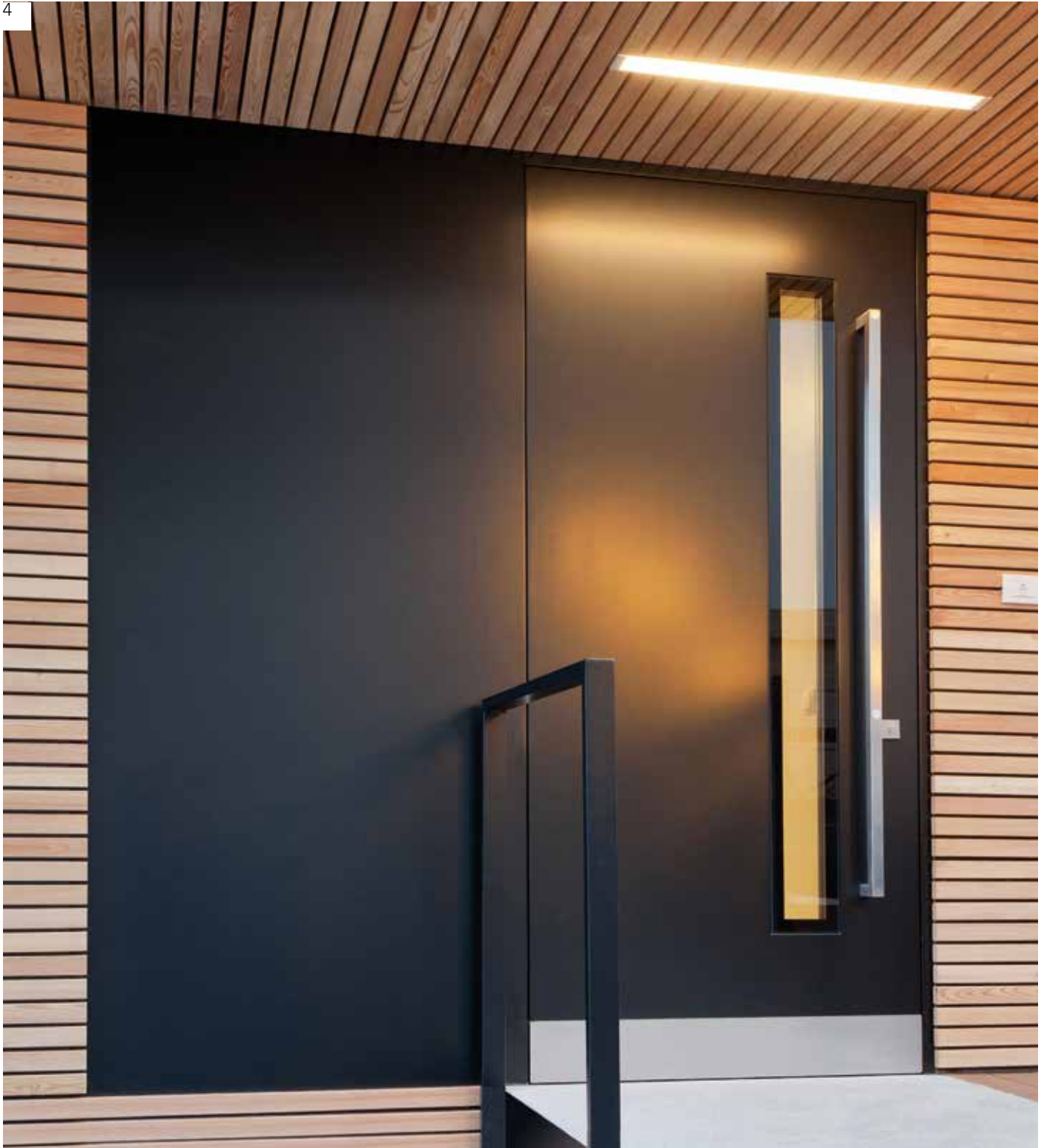

SOPRALUCI ED ELEMENTI LATERALI TRANSOM WINDOWS AND SIDE ELEMENTS



1

Sopraluci ed elementi laterali fissi
Transom windows and fixed side elements

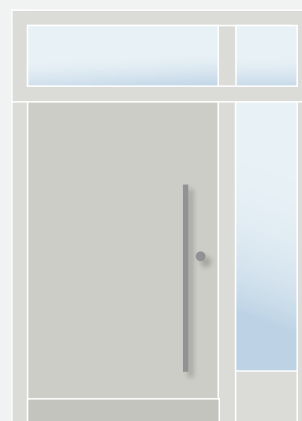
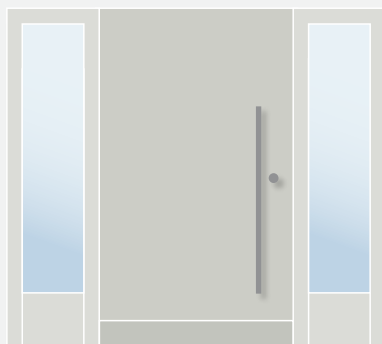
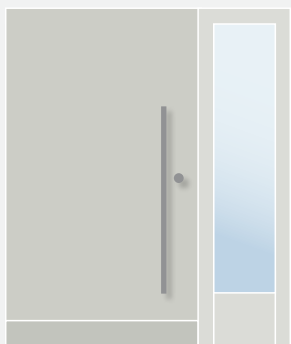



- 1 Portoncino modello H108 con elemento laterale S1 ad angolo a Termeno - Alto Adige
- 2 Portoncino modello H108 con elemento laterale S1 a Brunico - Alto Adige
- 3 Portoncino modello H91 con elemento laterale S1 e sopra luce, Carinzia - Austria

- 1 Front door model H108 with side element S1 over the corner in Termeno- South Tyrol
- 2 Front door model H108 with side element S1 in Brunico - South Tyrol
- 3 Front door model H91 with side element S1 and transom window, Carinthia - Austria

3

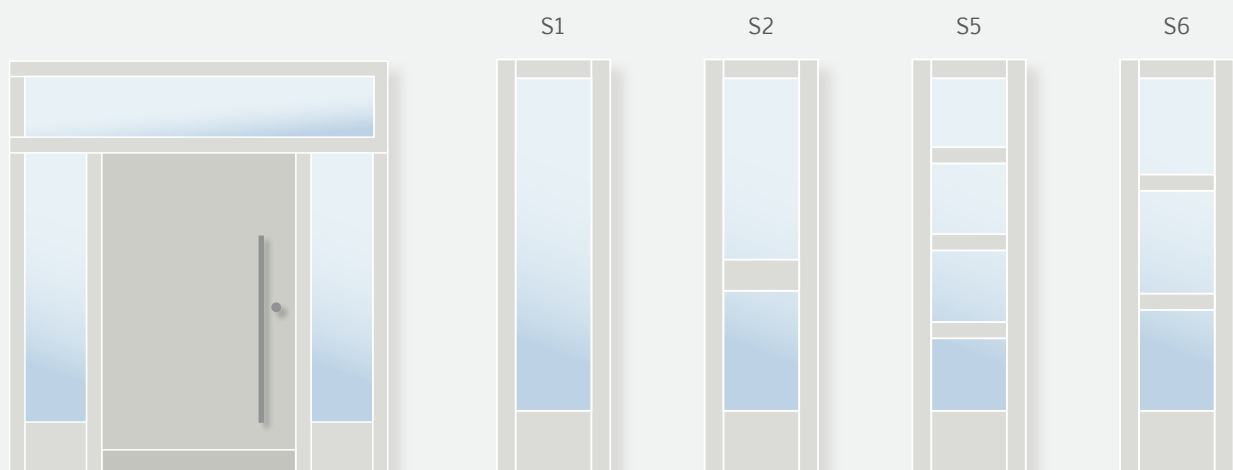

DESIGN TRADIZIONALE
TRADITIONAL DESIGN



Portoncino modello H101 con elemento laterale S1 a Sondrio - Italia / *Front door model H101 with side element S1 in Sondrio - Italy*



PORTONCINI TRADIZIONALI CASA CLIMA **ECO 100**[®]
TRADITIONAL CLIMATEHOUSE **ECO 100**[®] FRONT DOORS



1
2





3



4



5

- 1 Portoncino a filo, Pinzgau - Austria
- 2 Portoncino ad arco regolare, Renon - Alto Adige
- 3 Portoncino individuale ad arco regolare a Nova Levante - Alto Adige
- 4 Portoncino individuale ad arco ribassato presso Zurigo - Svizzera
- 5 Portoncino ad arco regolare a Miesbach - Germania

- 1 Flush front door, Pinzgau - Austria
- 2 Front door with round arch, Renon - South Tyrol
- 3 Individual front door with round arch in Nova Levante - South Tyrol
- 4 Individual front door with segmental arch, near Zurich - Switzerland
- 5 Front door with round arch in Miesbach - Germany





2



3

- 1 Portoncino modello H101 in Alto Adige
- 2 Portoncino modello H122 a Schliersee - Baviera
- 3 Portoncino con rivestimento in legno massiccio con motivo a stella ed elemento laterale S1 in larice con nodi a Bad Tölz - Germania

- 1 *Front door model H101 in South Tyrol*
- 2 *Front door model H122 in Schliersee - Bavaria*
- 3 *Front door with solid wood finish and star-shaped design with side element S1 in larch knotty, Bad Tölz - Germany*

- 1 Portoncino ad arco regolare con elemento laterale in Val Gardena - Alto Adige
- 2 Portoncino ad arco regolare modello RH98 in Val Sarentino - Alto Adige
- 3 Portoncino ad arco regolare per una villa in Alto Adige

- 1 *Front door with round arch and side element in Val Gardena - South Tyrol*
- 2 *Front door with round arch model RH98 in Val Sarentino - South Tyrol*
- 3 *Front door with round arch for a villa in South Tyrol*



1



2





- 1 Modello speciale con sopra luce presso Monaco di Baviera - Germania
- 2 Modello speciale con griglia in ferro battuto a Berna - Svizzera
- 3 Modello speciale a due ante con griglia, Veneto - Italia
- 4 Portoncino a design tradizionale a Rosenheim - Germania

- 1 *Special model with transom window near Munich - Germany*
- 2 *Special model with window grille in wrought iron, Berne - Switzerland*
- 3 *Special double model with window grille, Veneto - Italy*
- 4 *Traditional design front door in Rosenheim - Germany*







1



2

- 1 Portoncino ad arco regolare modello RH98 in Alto Adige
- 2 Portoncino modello H69 con elemento laterale S2 presso Monaco di Baviera - Germania
- 3 Portoncino modello H120 a Norimberga - Germania
- 4 Portoncino con sopra luce ad arco regolare, Renon - Alto Adige
- 5 Portoncino con sopra luce tondo, Allgäu - Germania
- 6 Modello speciale per una villa, Tegernsee - Germania

- 1 Front door with round arch model RH98 in South Tyrol
- 2 Front door model H69 with side element S2, near Munich - Germany
- 3 Front door model H120 in Nuremberg - Germany
- 4 Front door with round transom window, Renon - South Tyrol
- 5 Special element with round transom window, Allgäu - Germany
- 6 Special model for a villa, lake Tegernsee - Germany



3



4



5



6

NUOVO DESIGN IN LEGNO VECCHIO
NEW DESIGN WITH OLD WOOD



Portoncino modello Legno vecchio 2 con grande inserto in vetro in Tirolo del Nord - Austria

Front door model old wood 2 with large glass insert in North Tyrol - Austria



PORTONCINI CASA CLIMA ECO 100® IN LEGNO VECCHIO

Portoncini naturali, sostenibili in legno vecchio – un'altra innovazione di Rubner

il legno vecchio acquista sempre più importanza nella produzione dei portoncini grazie alla sua tradizione centenaria e alla bellezza naturale. Il portoncino Rubner in legno vecchio è apprezzato da architetti, committenti e partner commerciali che lo inseriscono in ambienti abitativi innovativi.



1, 2 Portoncino in legno vecchio per una casa Residence nella regione dell'Arlberg - Austria

3, 4, 5 Portoncini in legno vecchio per un centro turistico nella regione del Berchtesgadener Land - Germania

1, 2 *Old wood front door for a residence, in Arlberg - Austria*

3, 4, 5 *Old wood front door for a tourist resort, in Berchtesgadener Land - Germany*

CLIMATEHOUSE ECO100® FRONT DOORS IN OLD WOOD

Natural, sustainable old wood front doors – another Rubner innovation

Old wood is becoming increasingly popular in the production of front doors by virtue of age-old tradition and of its natural beauty. The Rubner old wood front door is acclaimed by architects, clients and business partners who use it in innovative living solutions.



3



4



5



1



2

1, 2, 3 Portoncini lisci in legno vecchio per "Jägerheim" in Alto Adige
Smooth old wood front doors for "Jägerheim" in South Tyrol

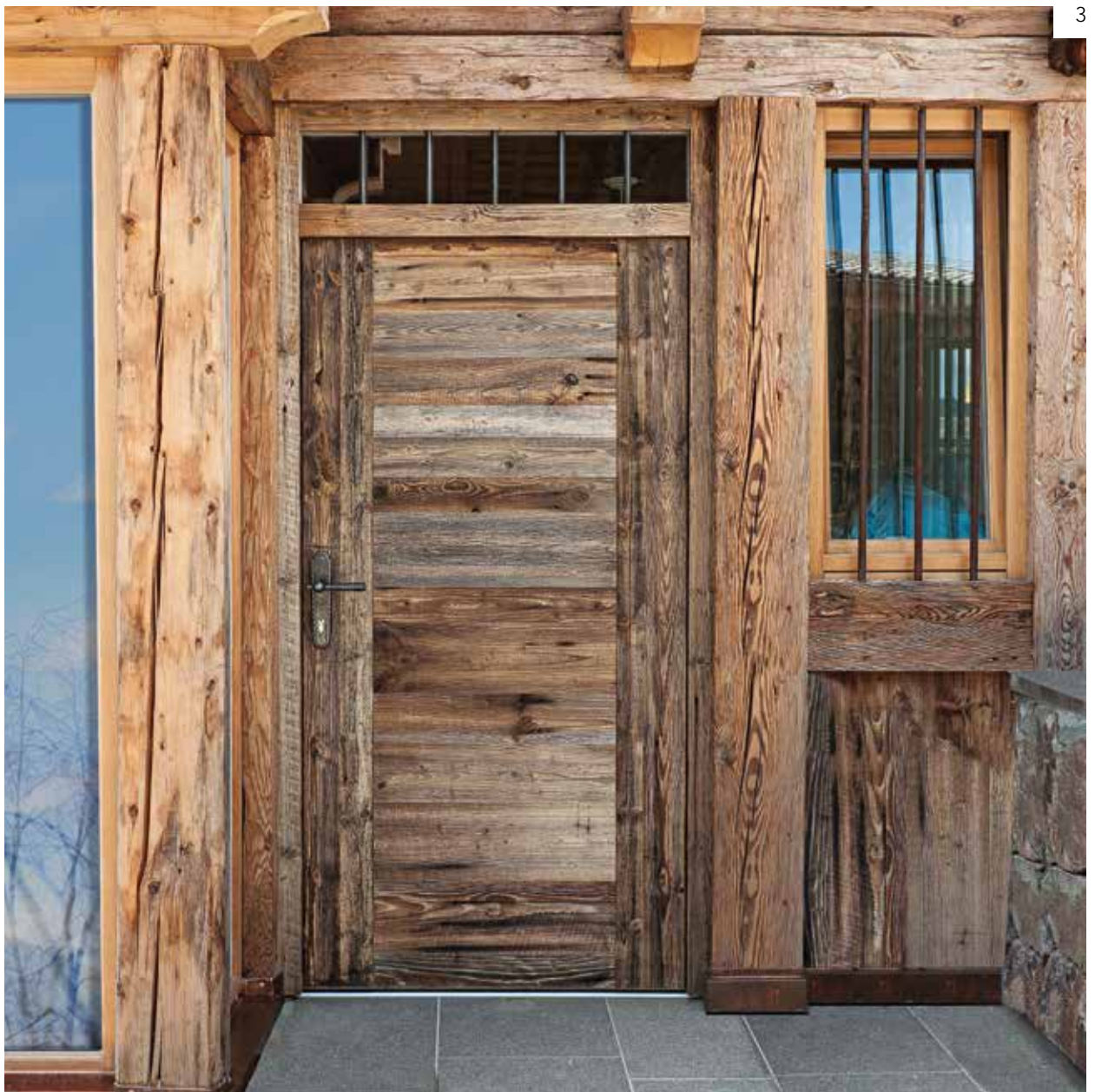

3



1, 2 Portoncino in legno vecchio per rifugio alpino negli Alpi di Kitzbühel - Austria
Old wood front door for an mountain hut in the Alps of Kitzbühel - Austria





1



2

- 1 Portoncino liscio in legno vecchio con elementi laterali S1, Tirolo del Nord - Austria
- 2 Portoncino modello Legno vecchio 1, Tirolo Orientale - Austria
- 3 Portoncino con rivestimento personalizzato in legno vecchio presso Kufstein - Austria
- 4 Portoncino con rivestimento in legno vecchio con motivo a stella ed elementi laterali S5 a Kitzbühel - Austria

- 1 Smooth old wood front door with side elements S1, North Tyrol - Austria
- 2 Old wood front door model 1, East Tyrol - Austria
- 3 Front door with customised old wood finish near Kufstein - Austria
- 4 Front door with old wood finish with star-shaped motif and side elements S5 in Kitzbühel - Austria



3



4



- 1** Portoncino con elementi laterali, superficie abete vecchio a spacco vicino a Kitzbühel - Austria
 - 2** Portoncino in legno vecchio con intarsi in legno vecchio con motivo a stella, Tirolo del Nord - Austria
-
- 1** *Front door with side elements, chopped spruce surface, near Kitzbühel - Austria*
 - 2** *Old wood front door with star-shaped inlays in old wood, North Tyrol - Austria*







Campioni di legno vecchio
Old wood samples



Abete vecchio a spacco e spazzolato
Old wood spruce chopped and brushed



Legno vecchio naturale (bruciato dal sole)
Natural old wood (sundried)



Legno vecchio scuro (bruciato dal sole)
Dark old wood (sundried)



Legno vecchio grigio (bruciato dal sole)
Grey old wood (sundried)

1, 2, 3 Portoncino liscio, con rivestimento in abete massiccio a trattamento "termo" ed elementi laterali in colore RAL 7016, Chiemsee - Germania
Smooth front door, thermal fir with solid wood finish and side elements in RAL colour 7016 in Chiemsee - Germany



Si fa presente che in virtù delle proprietà naturali del legno le immagini possono differire dal prodotto effettivo. Ciò non rappresenta un difetto, bensì una caratteristica di un materiale cresciuto naturalmente.

Please be aware that because of the natural properties of wood, the pictures may differ from reality. This is not a defect, but rather the distinguishing feature of a material (wood) that grows in a natural way.



1



2

- 1 Portoncino modello Legno vecchio 1 senza telaio in acciaio inox in Carinzia - Austria
- 2 Portoncino modello H139 in Val Passiria - Alto Adige
- 3 Portoncino in legno vecchio con grata in ferro battuto in Lombardia - Italia
- 4 Modello speciale a filo in Alto Adige

- 1 Old wood front door model 1 without stainless steel frame, Carinthia - Austria
- 2 Front door model H139 in Val Passiria - South Tyrol
- 3 Old wood door with window grille in wrought iron in Lombardia - Italy
- 4 Special model, flush front door in South Tyrol



3



4

**RIVESTIMENTO O
COPERTURA IN ROVERE
MASSICCIO CON NODI**

**OAK KNOTTY WITH SOLID
WOOD PANELLING OR
SOLID WOOD DOUBLING**



- 1 Portoncino modello H130 rivestito con rovere massiccio con nodi e vetro smaltato a Berchtesgaden - Germania
- 2 Portoncino modello H101 ricoperto con rovere massiccio con nodi, cornici e ferramenta in bronzo a Davos - Svizzera



1 2

- 1 Front door model H130 in oak knotty with solid wood panelling and enamelled glass, Berchtesgaden - Germany
- 2 Front door model H101 in oak knotty with solid wood doubling, door surrounds and fittings in bronze, Davos - Switzerland



Rovere con **nodi piccoli**
Oak knotty, **small knots**



Rovere con **nodi grandi**
Oak knotty, **large knots**



Rovere **fessurato**
Oak **cracky**

Si fa presente che in virtù delle proprietà naturali del legno le immagini possono differire dal prodotto effettivo. Ciò non rappresenta un difetto, bensì una caratteristica di un materiale cresciuto naturalmente.

Please be aware that because of the natural properties of wood, the pictures may differ from reality. This is not a defect, but rather the distinguishing feature of a material (wood) that grows in a natural way.

**PRODUZIONE SU MISURA
PER LE COSTRUZIONI SOTTOPOSTE
A TUTELA STORICO-ARTISTICA**



Modello speciale con sopra luce a Brindisi - Italia / *Special model with transom window in Brindisi - Italy*



**MADE TO MEASURE FOR
PROTECTION OF HISTORIC MONUMENTS**

PORTONCINI CASA- CLIMA ECO 100® PER RISTRUTTURAZIONI

Per trasformare il vecchio in nuovo

Le venerabili porte in legno mantengono il proprio carattere fin nei minimi dettagli ma, grazie al know how di Rubner in termini di protezione antieffrazione e di isolamento termico ed acustico, si arricchiscono di un valore aggiunto duraturo che permette di soddisfare le più moderne esigenze.

CLIMATEHOUSE ECO 100® FRONT DOORS FOR MONUMENT PROTECTION

From old to new

Venerable wood doors preserve their character down to the smallest details but thanks to Rubner's expertise in terms of burglar-, heat- and sound-proofing, they acquire a long-standing added value capable of meeting even the most modern requirements.



- 1 Portoncino a due ante con sopra luce per l'Università, cantone di Zurigo - Svizzera
- 2 Modello speciale con sopra luce con griglia in ferro battuto nel cantone di Zugo - Svizzera

- 1 Double front door with transom window for the University, Canton of Zurich - Switzerland
- 2 Special model with transom window grille in wrought iron, Canton of Zug - Switzerland





- 1 Portale sotto tutela artistica con sopraluce separato nel centro storico di Monaco di Baviera - Germania
- 2 Portoncino ad arco a sesto acuto in una cantina vini, Alto Adige

- 1 *House portal under preservation order, with separate transom window, in the historical centre of Munich - Germany*
- 2 *Pointed arch door, wine cellar in South Tyrol*

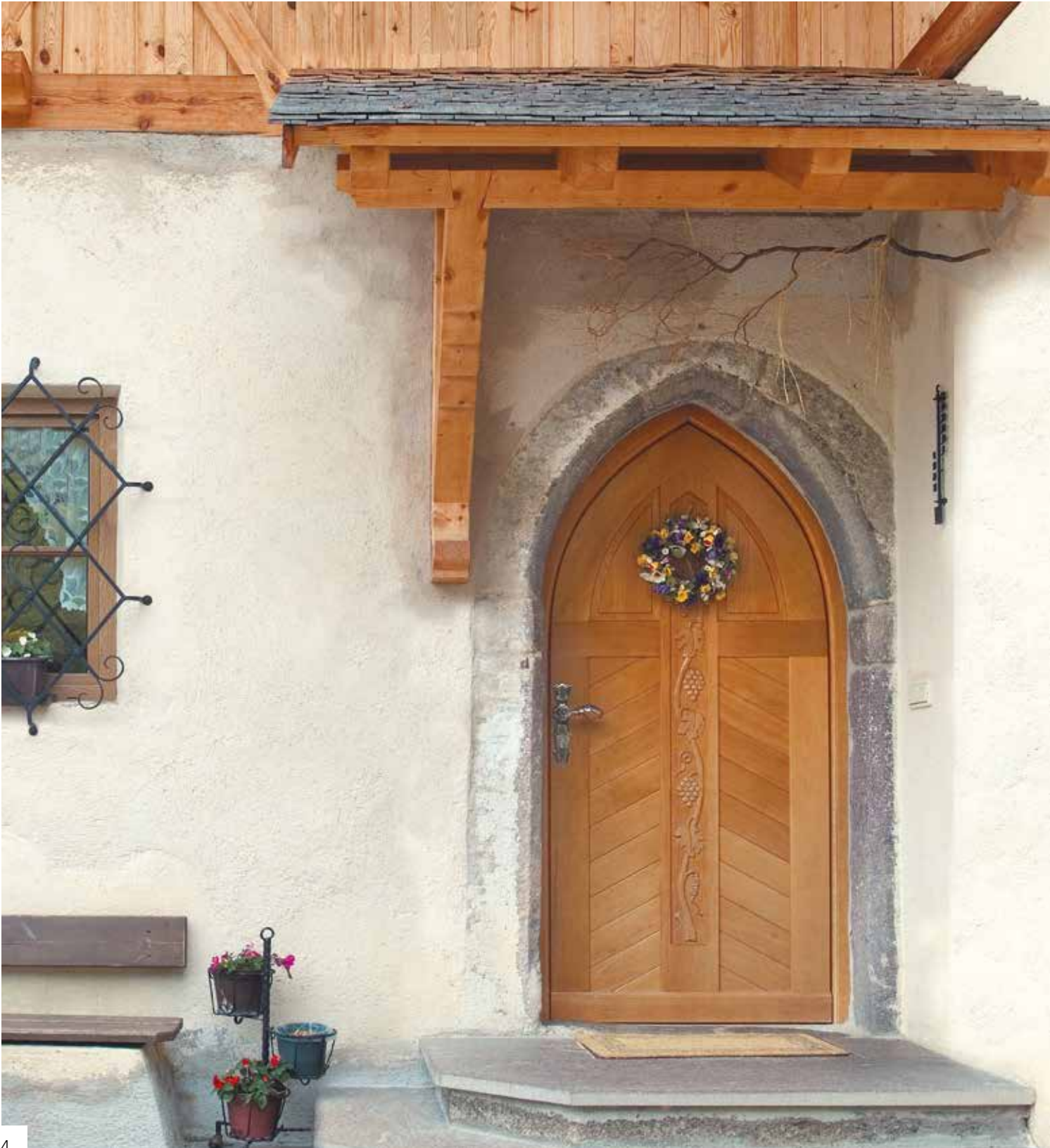

- 1 Portoncino del campanile
- 2 Vista d'insieme del campanile
- 3 Modello speciale con finestra apribile vicino a Berna - Svizzera
- 4 Vista di particolare
- 5 Portoncino prodotto secondo le prescrizioni dell'Ufficio beni architettonici e artistici a Monaco di Baviera - Germania
- 6 Portoncino speciale per una tenuta nei pressi di Brunico - Alto Adige

- 1 *Front door to a church-tower in South Tyrol*
- 2 *Full view of the church-tower*
- 3 *Special model with opening window, near Berne - Switzerland*
- 4 *Detail*
- 5 *Front door under preservation order, in Munich - Germany*
- 6 *Special front door for an estate near Brunico - South Tyrol*



1



2



3



4



5



6





**Cappella presso la casa d'origine
della famiglia Rubner,
Alto Adige**

*Chapel near the original home
of the Rubner family,
South Tyrol*



**PROTECTA® LA RISPOSTA ALLE VERSIONI
IN LEGNO-ALLUMINIO**



Portoncino ad arco ribassato modello Protecta 2 con elemento laterale a Obersdorf - Germania

Front door with segmental arch model Protecta 2 with side element in Obersdorf - Germany



**PROTECTA® THE ANSWER TO
WOOD-ALUMINUM**

PROTECTA®
ALL'ESTERNO
MAX-EXTERIOR
ALL'INTERNO LEGNO

PROTECTA®
MAX-EXTERIOR
ON THE OUTSIDE
WOOD ON THE INSIDE





Indeformabilità,
pregio estetico e
facile manutenzione

*Dimensionally stable,
aesthetic,
easy-care surface*

**Ma le esigenze particolari necessitano
di soluzioni specifiche:**

I portoncini delle linee certificate PROTECTA® e PROTECTA DESIGN® di Rubner Porte sono particolarmente resistenti alle intemperie senza però rinunciare alle prerogative del legno sul lato interno.

Special needs need special solutions:

The front doors of the certified lines PROTECTA® and PROTECTA DESIGN® by Rubner Doors are especially resistant to weather and easy to maintain on the outside without renouncing the strengths of wood on the inside.

3



- 1 Modello speciale con elemento laterale S1 a Caldarò - Alto Adige
- 2 Portoncino ad arco regolare a Chiusa - Alto Adige
- 3 Portoncino ad arco regolare a Longostagno, Renon - Alto Adige

- 1 *Special model with side element S1 in Caldarò - South Tyrol*
- 2 *Front door with round arch in Chiusa - South Tyrol*
- 3 *Front door with round arch in Longostagno, Renon - South Tyrol*





- 1** Portoncino modello Protecta 2 con elemento laterale S1, Tirolo Orientale - Austria
- 2** Portoncino modello Protecta 3 a Villacco - Austria
- 3** Portoncino individuale a Berlino - Germania

- 1** Front door model Protecta 2 with side element S1 in Eastern Tyrol - Austria
- 2** Front door model Protecta 3 in Villach - Austria
- 3** Front door on demand in Berlin - Germany

2



3

**ALL'ESTERNO PROTECTA®
ALL'INTERNO BIANCO**

**PROTECTA® ON THE OUTSIDE
WHITE ON THE INSIDE**

- 1 Modello speciale con tamponamenti
nei pressi di Como - Italia, vista esterna
- 2 Vista interna

- 1 *Special model with panelling,
near Como - Italy, external view*
- 2 *Interior view*





3 Modello Protecta a Monaco di Baviera - Germania
Model Protecta in Munich - Germany

3



2

1 Portoncino modello Protecta 2 con elemento laterale S1 presso Lindau - Germania

1 Front door model Protecta 2 with side element S1 near Lindau - Germany





- 1 Portoncino modello Protecta 1 a Schongau - Germania
- 2 Ingresso per un negozio a Monaco di Baviera - Germania

- 1 *Front door model Protecta 1 in Schongau - Germany*
- 2 *Shop entrance in Munich - Germany*

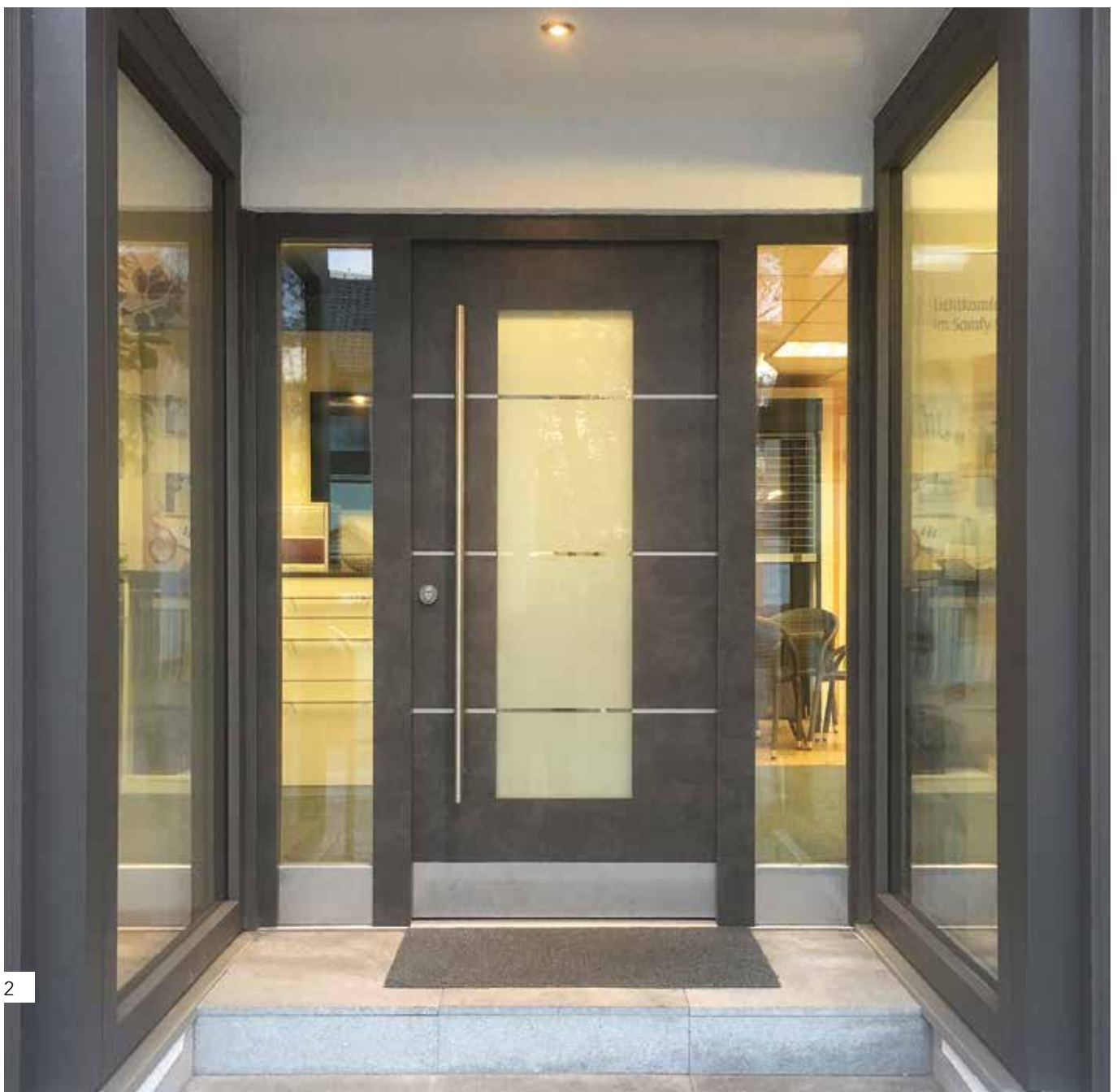

SORPRENDETE GLI OSPITI CON IL VOSTRO GUSTO PARTICOLARE

Superficie Max-Exterior sul lato esterno

- Di facile manutenzione, estremamente resistente
- Una protezione e una durezza senza eguali verso tutte le influenze esterne
- Colori, motivi e superfici diversi

SURPRISE YOUR GUESTS WITH YOUR EXQUISITE TASTE

Max-Exterior surface on the outside

- Easy maintenance, extremely resistant
- Consistent protection and durability against any external influence
- Assorted colours, patterns and surfaces

1 Portoncino modello Protecta 2 con elemento laterale S1 a Castelrotto - Alto Adige
Front door model Protecta 2 with side element S1 in Castelrotto - South Tyrol





0426 Loft



0421 Venus



0496 Colosseum



0497 Stonehenge



0344 Riverside



0932 Akro Terra



0794 Patina Bronzo / *bronze*



0027 Prado Agate Grey



0159 Afro Black



0077 Charcoal



0070 Carbon Grey

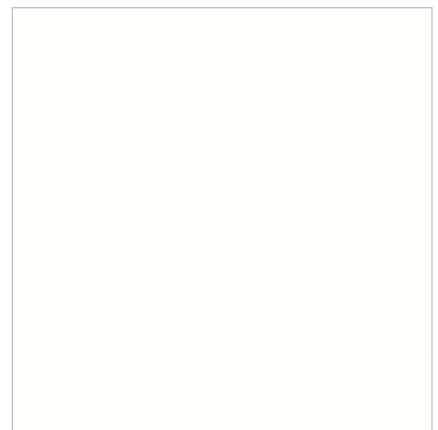

0085 Bianco / white

PORTALI STRAVAGANTI EXTRAVAGANT PORTALS



Portoncino con rivestimento in bronzo sul lato esterno a San Tropez - Francia

Wooden front door with bronze finish on the outside in Saint Tropez - France



PORTONCINI MONDANI CASA CLIMA **ECO 100**[®]
SOPHISTICATED CLIMATEHOUSE **ECO 100**[®] FRONT DOORS



- 1 Portoncino in legno con rivestimento in bronzo sul lato esterno in Alto Adige
- 2 Portoncino in legno con rivestimento in acciaio Corten sul lato esterno a Innsbruck - Austria

- 1 *Wooden front door with bronze finish on the outside in South Tyrol*
- 2 *Wooden front door with Corten steel external finish on the outside, in Innsbruck - Austria*



2

- 1 Portoncino con rivestimento in bronzo sul lato esterno a Padova - Italia
- 2 Modello speciale con applicazioni in acciaio inox ed elemento laterale S1, Baden-Württemberg - Germania
- 3 Modello speciale a filo con rivestimento in acciaio inox, Torino - Italia

- 1 *Front door with bronze finish on the outside, Padova - Italy*
- 2 *Special model with stainless steel applications and side element S1, Baden-Württemberg - Germany*
- 3 *Special flush model with stainless steel finish, Torino - Italy*



- 1 Portoncino in legno con rivestimento esterno in bronzo a Bolzano - Alto Adige
Wood front door with bronze finish on the outside in Bolzano - South Tyrol



NUOVI SOLUZIONI PER IL RISANAMENTO
NEW SOLUTIONS FOR REDEVELOPMENT



Portoncino ad arco policentrico a doppio battente a Roma - Italia / *Double door with basket arch in Rome - Italy*



INTERVENTO DI RISANAMENTO CON PORTONCINI CASA CLIMA **ECO 100**[®]

Ogni porta ha un proprio carattere e una sua storia. Quando si ristruttura una casa, spesso è anche necessario ridare smalto alla vecchia porta o sostituirla con un modello a risparmio energetico.

LA MATTINA
porta vecchia



TUTTO IN UN GIORNO: smontaggio e rimontaggio a regola d'arte di portoncini



LA SERA
porta nuova



Rubner Porte offre molteplici soluzioni: dalla riproduzione fedele di un modello vecchio stile, che sarà comunque dotato di tutti i necessari accorgimenti tecnici, o alla fornitura di una porta nuova scelta dal vasto assortimento di portoncini. La sostituzione è assolutamente rapida, tanto che al mattino uscirete di casa e la sera troverete la porta nuova montata.

Protezione in fase di costruzione

Per garantire che il vostro portoncino in legno Rubner rimanga in perfetto stato, occorre adottare le seguenti misure già durante la fase di costruzione e di montaggio.

- In caso di lavori di intonacatura proteggere accuratamente la superficie del portoncino in legno con del nastro adesivo, ad es. Tesa 4438 o 4838. Rimuovere queste pellicole e il nastro adesivo quanto prima e comunque entro due settimane.
- Verificare che nessun residuo di intonaco e malta imbratti la ferramenta perché sarebbe difficile da eliminare.
- Per pulire la superficie dopo il montaggio non utilizzare in nessun caso prodotti aggressivi (ad es. detersivi a base di solventi, prodotti abrasivi, detersivi alcalini multiuso) perché deteriorano la superficie. Per pulire a umido il portoncino in legno utilizzare di norma solo saponi neutri o detersivi multiuso neutri.
- I residui di sporco insistenti e tenaci, come ad esempio i resti di gesso o malta, si possono eliminare facilmente e senza rovinare le superfici utilizzando una spatola in legno o in plastica.
- In presenza di un tenore di umidità dell'aria superiore al 70% si presume, ai sensi della norma DIN 18355, che l'umidità della costruzione sia troppo elevata per gli elementi in legno. Il committente deve adottare le misure necessarie per non superare tale soglia e senza che gli venga richiesto. Si declina qualsiasi responsabilità e l'onere della prova in caso di eventuali danni riconducibili a tale circostanza.



1

- 1 Portoncino con elementi laterali a Falzes - Alto Adige
- 2 Portoncino modello H2 con inglesina in legno, Trentino
- 3 Portoncino per una malga alpina a Cortina - Belluno

- 1 *Front door with side elements in Falzes - Alto Adige*
- 2 *Front door model H2 with wooden glazing bars in Trentino*
- 3 *Front door for a chalet in Cortina - Belluno*



2



3



PRIMA

DOPO





PRIMA



DOPO





- Sostituzione della porta in brevissimo tempo
- Possibilità di ricevere contributi per interventi di risparmio energetico
- Elevata resistenza per un'ottima protezione antieffrazione
- Sistema costruttivo ultramoderno ed ecosostenibile

PRIMA

DOPO





PRIMA

DOPO



ESTERNO E INTERNO – SOLUZIONI INDIVIDUALI OUTSIDE AND INSIDE – INDIVIDUAL SOLUTIONS

1, 2 Portoncino in legno con rivestimento esterno in bronzo, impiallacciatura trasversale in rovere sul lato interno

Wooden front door with bronze finish on the outside, oak cross veneered on the inside



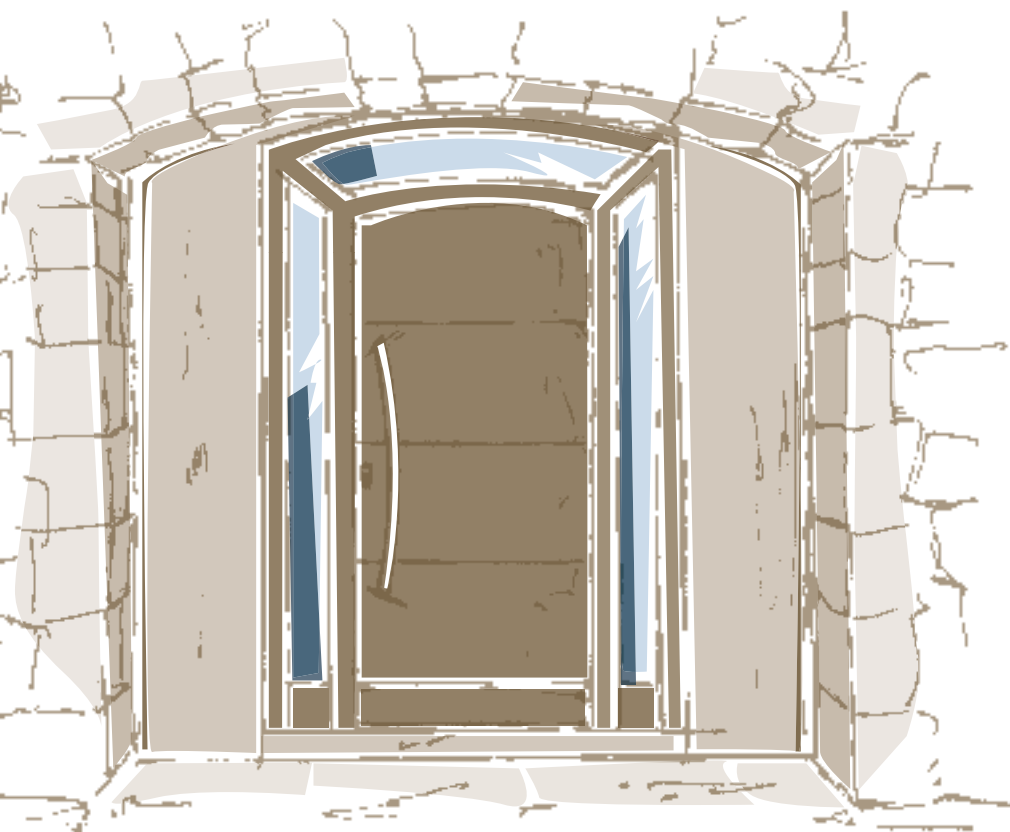

Configurazione della propria porta

Comunicateci le vostre idee e i vostri desideri: noi li realizzeremo. Ogni portoncino Rubner è un pezzo unico. Con le vostre idee e il nostro know how produciamo la porta dei vostri sogni, su misura.

Customising your door

Send us your ideas and your requirements, and we will meet them. Each Rubner front door is a individual designer item. With your ideas and our know-how we can produce your front door on demand.





1



2



3

- 1, 2** Portoncino modello H131 nella regione del Berner Oberland - Svizzera, con elementi laterali, esterno in colore RAL, interno in rovere con nodi
3, 4 Elemento portoncino a filo nei pressi di Merano - Alto Adige, esterno in colore RAL, interno con impiallacciatura obliqua in noce

- 1, 2** Front door H131 model in the Berner Oberland region - Switzerland, with side elements, external side in RAL colours, internal side in oak knotty
3, 4 Flush front door element near Merano - South Tyrol, outside in RAL colour, inside walnut cross veneered



4

IN SINTONIA CON L'AMBIENTE ESTERNO E INTERNO

I portoncini CasaClima di Rubner possono essere adattati perfettamente all'arredo interno e alle porte interne, con impiallacciatura in essenze legnose pregiate o con verniciatura nei colori RAL.

IN HARMONY WITH THE EXTERNAL AND THE INTERNAL ENVIRONMENT

ClimateHouse front doors by Rubner can be perfectly matched with the interior furnishing and to the style of the internal doors, using precious wood veneering or by painting with RAL colours.

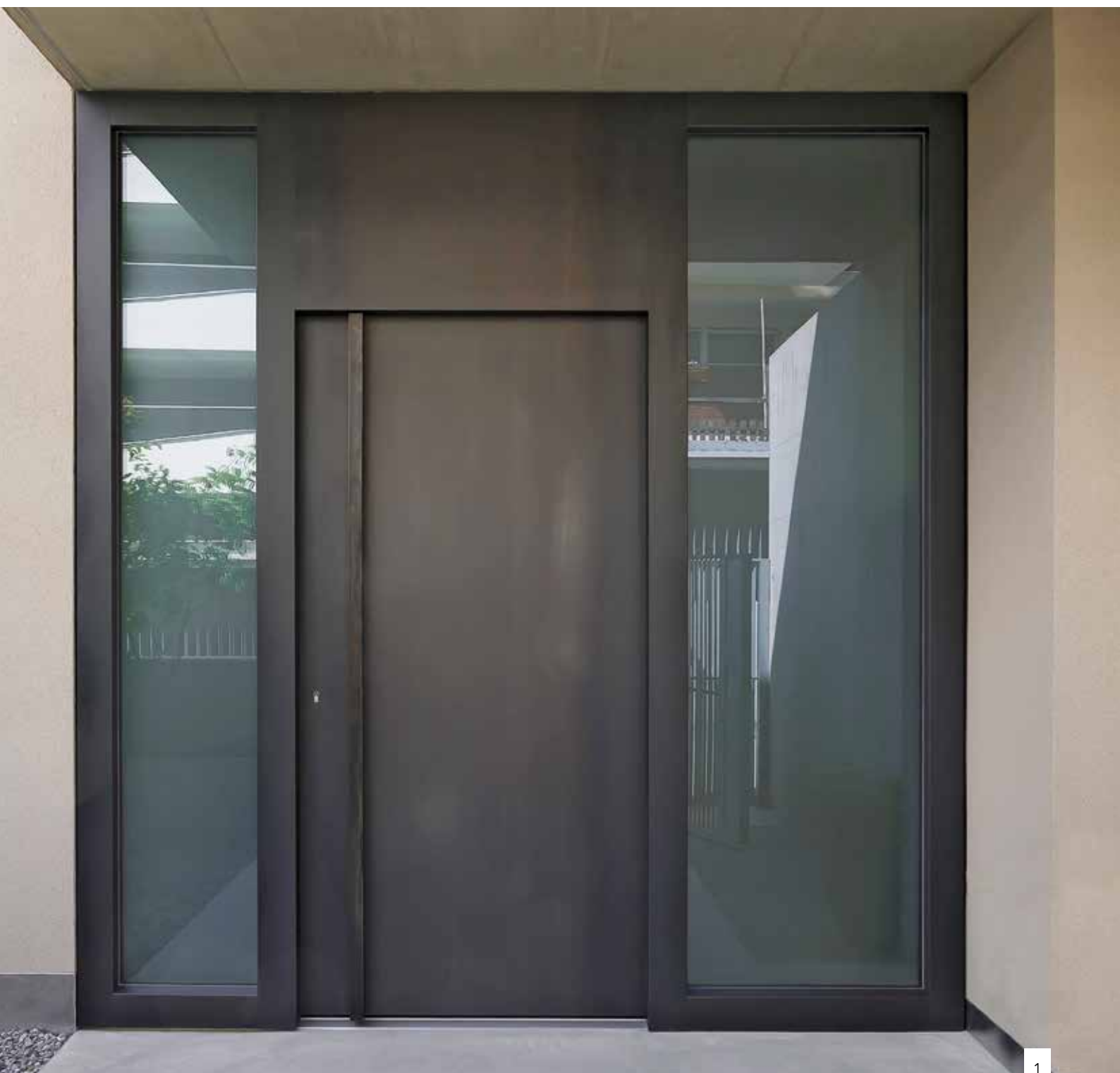

- 1, 2** Portoncino rivestito in acciaio nero sul lato esterno, con impiallacciatura trasversale in larice sul lato interno
Front door with black steel finish on the outside, larch cross veneered on the inside

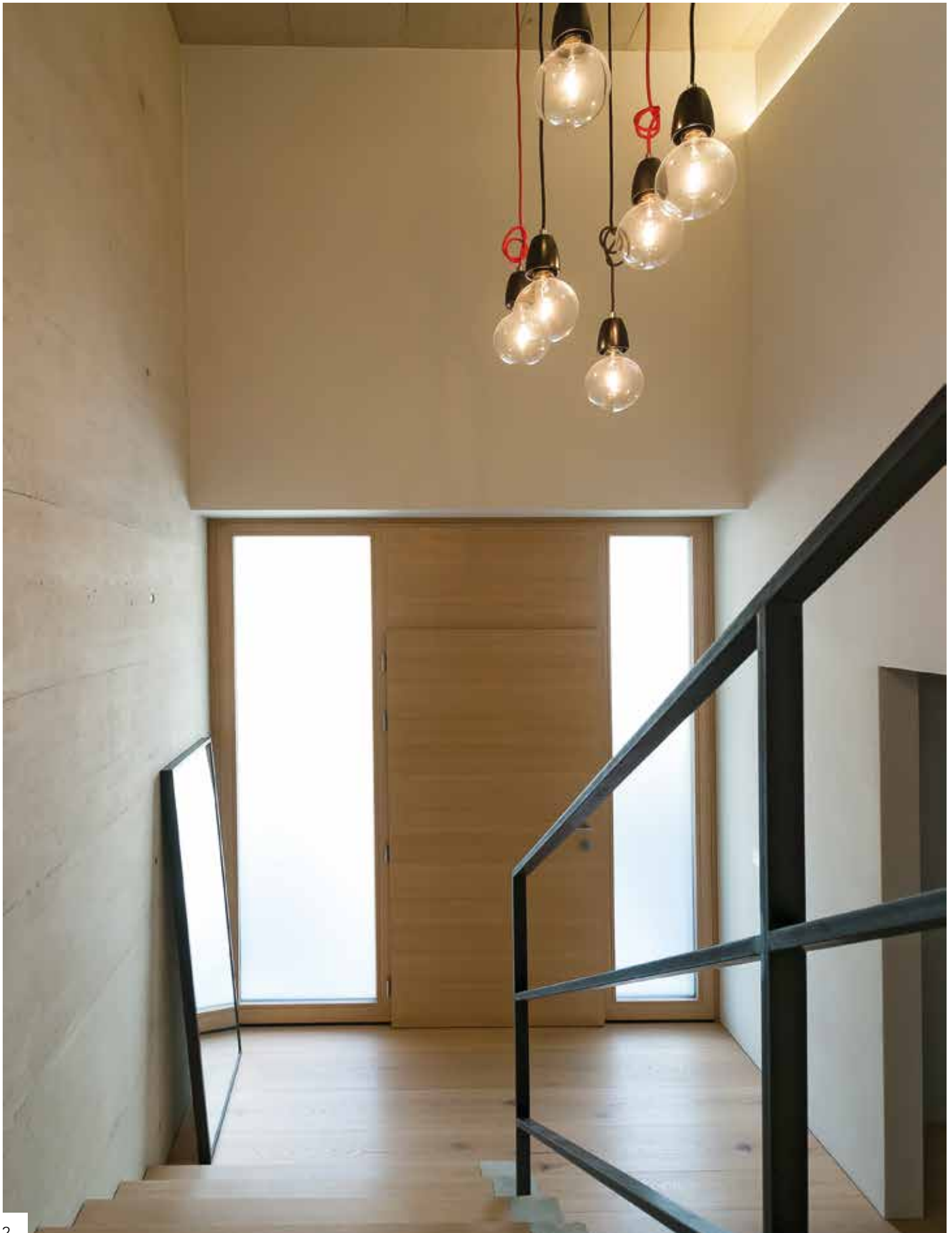

PERCHÈ I PORTONCINI RUBNER SONO MIGLIORI

WHY RUBNER FRONT DOORS ARE THE BEST



Sono molti i vantaggi che fanno preferire i portoncini CasaClima **ECO 100**® Rubner:

- Design individuale – ogni portoncino viene realizzata su misura
- Precisione artigianale – tecnologia all'avanguardia e processi produttivi innovativi
- Certificazione CE di idoneità per varie classi climatiche e per diversi tipi di sollecitazione
- Elevato livello di protezione anti-effrazione, di isolamento acustico e di protezione antincendio, di ermeticità e di resistenza alla pioggia battente, confermato dalle prove effettuate dall'istituto di collaudo dei componenti edili PFB di Rosenheim (D).
- Ampia scelta di essenze pregiate – realizzazione in tutti i colori RAL e NCS
- Specialisti nel campo dei portoncini per ristrutturazioni di edifici – per trasformare il vecchio in nuovo
- Montaggio a regola d'arte – servizio di assistenza affidabile
- Valido rapporto qualità/prezzo
- Oltre 40 anni di esperienza

Il marchio di qualità applicato ad ogni portoncino Rubner conferma la rispondenza ai massimi standard di qualità.

The many advantages of choosing a Rubner ClimateHouse **ECO 100**® front door:

- Individual design – each front door is made to measure
- Handcrafting precision – leading technology and innovative production processes
- CE certified in regards of adequacy for various climate classes and stress classes
- Very high burglar-proofing, sound-proofing, fire resistance, air-tightness and rain penetration resistance characteristics confirmed by tests carried out by the building components test institute PFB in Rosenheim (D).
- Ample selection of high quality woods – availability of all RAL and NCS system colours
- Specialized in front doors for restructuring purposes – transforming old into new
- High craftsmanship in assembly – reliable assistance service
- Very good value for the money
- Over 40 years of experience

The quality trademark applied to every Rubner front door is proof of its compliance with the most demanding quality standards.



Si fa presente che in virtù delle proprietà naturali del legno le immagini possono differire dal prodotto effettivo. Ciò non rappresenta un difetto, bensì una caratteristica di un materiale cresciuto naturalmente. La ditta si riserva variazioni tecniche.

Please be aware that because of the natural properties of wood, the pictures may differ from reality. This is not a defect, but rather the distinguishing feature of a material (wood) that grows in a natural way. The company reserves the right to technical changes.

RISPARMIO ENERGETICO CON I PORTONCINI

SAVE ENERGY WITH OUR FRONT DOORS



Portoncini per CasaClima A

I punti di forza del portoncino CasaClima

ECO100® Rubner:

- Soddisfazione dei requisiti richiesti per porte esterne in materia di abitazioni a basso consumo energetico e di CasaClima classe B e A
- Ottimi valori termoisolanti (a seconda del modello), valore Ud 0,9 - 1,1 W/(m²K)
- Interno battente in legno/sughero (spessore 74 mm)
- Possibilità di scegliere diverse guide di scorrimento a pavimento a taglio termico
- Vetri standard isolanti Ug 1,1 – a scelta anche con coefficiente di trasmittanza termica di 0,7 o 0,5 W/(m²K)
- porte sottoposte a prove climatiche secondo DIN EN 1530 nei climi di prova c, d ed e con raggiungimento della classe massima di tolleranza 4

Front doors for ClimateHouse A

The strong points of the Rubner ClimateHouse

ECO100® front door:

- Compliance with the requirements for external doors intended for low energy consumption houses - CasaClima categories B and A
- Excellent heat insulation characteristics (Ud value from 0.9 to 1.1 W/(m²K) according to the model)
- Insulating core made of cork (thickness 74 mm)
- Choice of various thermal-break thresholds
- Standard Ug 1.1 insulating glass panes – also available with 0.7 or 0.5 W/(m²K) thermal transmittance
- Climate tests passed according to DIN EN 1530 standards in test climates c, d and e with maximum tolerance class 4 achieved

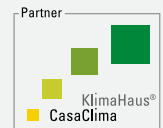

Portoncini per case passive

I punti di forza del portoncino

per case passive Rubner:

- Coefficiente U del battente 0,55 W/(m²K)
- Coefficiente Ud dell'elemento completo 0,74 W/(m²K)
- Coefficiente Ud dell'elemento installato 0,80 W/(m²K)
- Possibilità di combinazione con vetro isolante a 2 camere Ug = 0,7 o 0,5 W/(m²K)
- Eccellenti caratteristiche di ermeticità all'aria Q100 = 1,72 m³/(hm) – valore prescritto: 2,25 m³/(hm)
- Spessore del battente pari a 84 mm
- Spessore del telaio pari a 100 mm
- Verificato e certificato dal Passivhaus Institut di Darmstadt

Front doors for passive houses

The strong points of the main entrance doors for

Rubner passive houses:

- U value of leaf: 0.55 W/(m²K)
- Ud value of complete element: 0.74 W/(m²K)
- Ud value of installed element: 0.80 W/(m²K)
- Possible combination with double insulation glazing Ug = 0.7 or 0.5 W/(m²K)
- Excellent air-tightness characteristics Q100 = 1.72 m³/(hm) – required value: 2.25 m³/(hm)
- Leaf thickness: 84 mm
- Frame thickness: 100 mm
- Verified and certified by Passivhaus Institut, Darmstadt



Portoncino in legno Minergie® per la Svizzera

Valore Ud certificato da 0,9 a 1,1 W/m²K

Le nostre porte rispondono ai requisiti standard Minergie®, stabiliti dai Cantoni, dalla Confederazione e dal mercato. Una porta Minergie® risponde agli attuali standard della tecnica e in particolare ne soddisfa i requisiti per quanto riguarda la termoisolazione, la resistenza e la tenuta; offre inoltre un buon rapporto qualità-prezzo.

Minergie® wood front door for Switzerland

Certified Ud value (heat transmission)

from 0.9 to 1.1 W/(m²K)

Our doors comply with Minergie® standards set by Cantons, by the Confederation and by the market. A Minergie® door meet current technical standards and in particular satisfies demands as to heat insulation, strength and air sealing; also offering a good price/quality ratio.



PORTONCINI DI SICUREZZA

SECURITY FRONT DOORS

Portoncino di sicurezza Rubner RC2 (WK 2)

Portoncini antiscasso in legno della classe di resistenza RC 2 (classe II)

- Dimensioni: L 1.300 x A 2.500 mm – L 2.500 x A 2.500 mm (con elemento laterale)
- Ferramenta: Cilindro sagomato DIN 18252-21-BZ / DIN 18257-ES 1 – DIN 18252-21-BS / DIN 18257-ES 1-ZA
- Vetratura: DIN EN 356 classe di resistenza P4A

Rubner RC2 security front door (WK2)

Burglar-proof wood front door, resistance class RC 2

- Size: L 1,300 x H 2,500 mm – L 2,500 x H 2,500 mm (with side element)
- Hardware: Profiled drum DIN 18252-21-BZ / DIN 18257-ES 1 – DIN 18252-21-BS / DIN 18257-ES 1-ZA
- Glazing: DIN EN 356 resistance class P4A



**Certificato / Certified
DIN EN 1627**

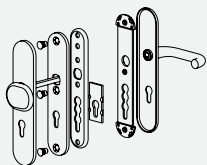

Ferramenta di sicurezza ES 1
Security hardware ES 1



Rosetta di sicurezza (RC2)
Security washer (RC2)



AS 2600 TSH AS 2600 AS 2300

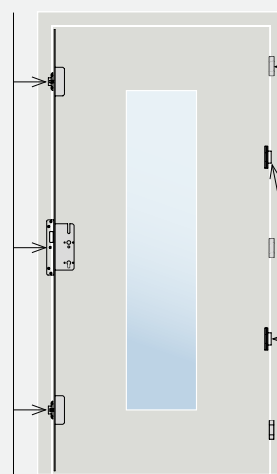

Cerniere Herkula
a tre perni
3-pin Herkula
hinges

Cerniere 3D
registrabili
(a scelta)
Adjustable 3D
hinges (choice of)

Rostri di sicurezza
Hinge protection

Portoncino di sicurezza Rubner RC3 (WK3)

Portoncini antiscasso in legno della classe di resistenza WK 3 (classe III)

- Dimensioni: L 1.300 x A 2.500 mm – L 2.500 x A 3.000 mm (con elemento laterale/sopraluce)
- Ferramenta: Cilindro sagomato DIN 18252-21-BZ / DIN 18257-ES 2 – DIN 18252-21-BS / DIN 18257-ES 1-ZA
- Vetratura: DIN EN 356 classe di resistenza P5A

Rubner RC3 security front door (WK3)

Burglar-proof wood front door, resistance class WK 3

- Size: L 1,300 x H 2,500 mm – L 2,500 x H 3,000 mm (with side element/transom window)
- Hardware: Profiled drum DIN 18252-21-BZ / DIN 18257-ES 2 – DIN 18252-21-BS / DIN 18257-ES 1-ZA
- Glazing: DIN EN 356 resistance class P5A



**Certificato / Certified
DIN EN 1627**

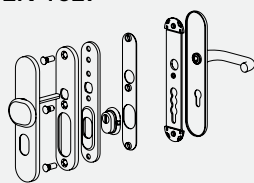

Ferramenta di sicurezza ES 2
Security hardware ES 2

AS 2608

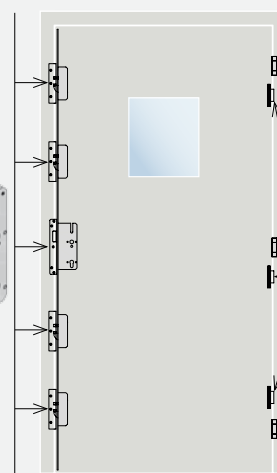

Cerniere Herkula
a tre perni
3-pin Herkula
hinges

Rostri di sicurezza
Hinge protection

ELEVATA PROTEZIONE

WELL PROTECTED



Protezione antieffrazione

Le porte Rubner: le prime porte in legno in Italia con **classi di resistenza RC 2 (WK 2) e RC 3 (WK 3)**, offrendo così la stessa protezione delle pregiate porte blindate in metallo.

Porta antintrusione
DIN EN 1627
Certificato n. ZE 1-T036
Certificato n. ZE 1-T037



Burglary protection

Rubner doors are the first wooden doors to be tested to **resistance class 2 and 3** throughout Italy. They thus offer the same degree of protection as a high-quality armoured metal door.



Burglar-resistant door
DIN EN 1627
Certificate No. ZE 1-T036
Certificate No. ZE 1-T037

Protezione tagliafuoco

Ogni portoncino Rubner è disponibile in versione tagliafuoco e in Italia, Austria e Svizzera sono certificati nella **classe di resistenza al fuoco EI 30** (resistenti alla fiamma per 30 minuti).

Fire protection

Rubner front doors are available in fire break versions and in Italy, Austria and Switzerland are rated **Fire Resistance Class EI 30** (resistant to flames for 30 minutes).

Resistenza al vento e alla pioggia battente

I portoncini Rubner proteggono contro le spiacevoli capriole del tempo - temporali, raffiche di vento, pioggia, gelo e calore -, fanno risparmiare energia e migliorano l'ambiente abitativo.

La tenuta alla pioggia battente dei portoncini Rubner soddisfa i requisiti della **classe 9A** (differenza pressione di prova **600 Pa**).

Resistance to wind and driving-rain

Rubner front doors protect against the unpleasant outbursts of the weather – rainstorms, gusting wind, rain, cold and heat, – help you save energy and improve your living environment.

The driving-rain resistance performance of Rubner front doors meets the requirements of **class 9A** (test pressure difference **600 Pa**).

Protezione antirumore

Le porte Rubner garantiscono un sonno tranquillo e offrono un'elevata protezione antirumore fino a 42 dB in conformità con DIN 4109.

- $R_w (C, C_{tr}) = 42 (-1, -5) \text{ dB}$
- Risultato straordinario: valore Ud (0,9 - 1,1) in combinazione con un coefficiente di abbattimento acustico di 42 db



È stato certificato dal Pfb - centro di prove sui materiali da costruzione di Rosenheim
Certified by Pfb - construction material testing centre in Rosenheim

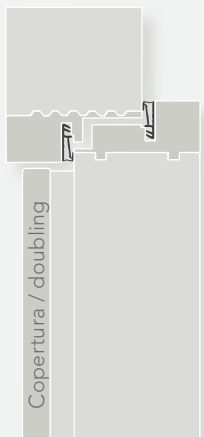

Copertura fonoassorbente dei portoncini CasaClima di Rubner
Soundproofing doubling of ClimateHouse front doors by Rubner

- 1 Portoncino liscio con copertura fonoassorbente a Rosenheim - Germania
Smooth front door with soundproofing doubling in Rosenheim - Germany

Noise protection

Rubner doors ensure a quiet night's sleep and provide superior noise control of up to 42 dB according to DIN 4109.

- $R_w (C, C_{tr}) = 42 (-1, -5) \text{ dB}$
- Extraordinary result: Ud value (0.9 - 1.1) in combination with a sound reduction coefficient of 42 dB



Profili telaio
Frame profiles

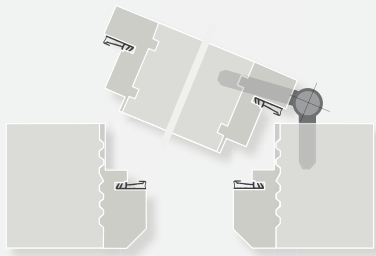

Dimensioni intelaiatura = misura ordine
Size of frame = order measurements

Telaio smussato, apertura: DIN sinistra
Chamfered frame, opens: DIN left

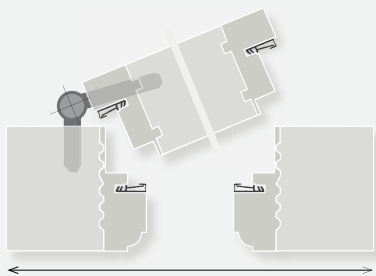

Telaio sagomato, apertura: DIN destra
Modelled frame, opens: DIN right

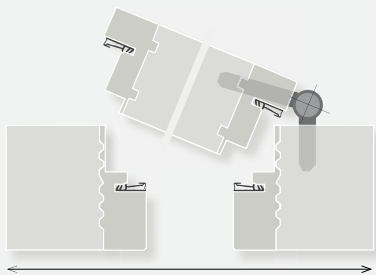

Telaio a spigolo, apertura: DIN sinistra
Sharp corner frame, opens: DIN left

Soglie
Thresholds

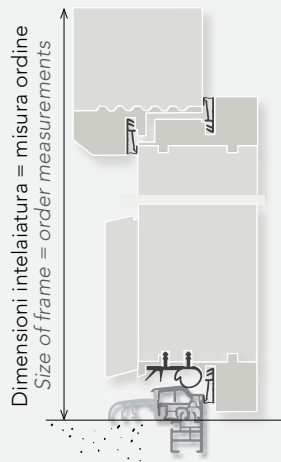

TH 60 - soglia termica 60
con profilo di allargamento, plastica 20
*TH 60 - heat profile 60
with plastic extension profile 20*

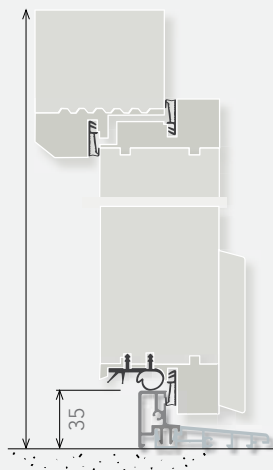

HTS 23 (apertura verso l'esterno)
HTS 23 (opens outwards)

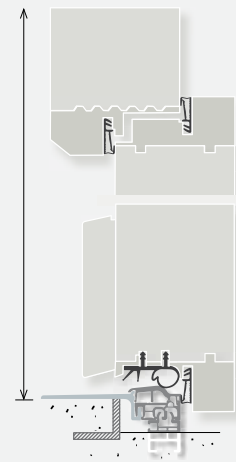

A-TR (soglia per interventi di ristruttur.)
con profilo di allargamento, plastica 20
*A-TR (threshold for restructuring operations)
with plastic extension profile 20*

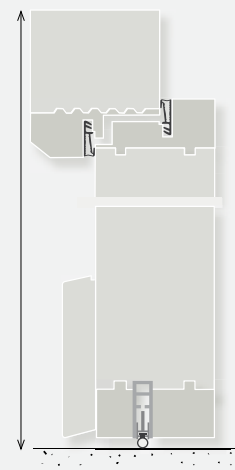

Protezione antifreddo
Protection from cold

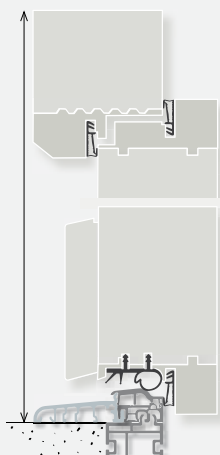

TH 80 - soglia termica 80
con profilo di allargamento, plastica 35
*TH 80 - heat profile 80
with plastic extension profile 35*

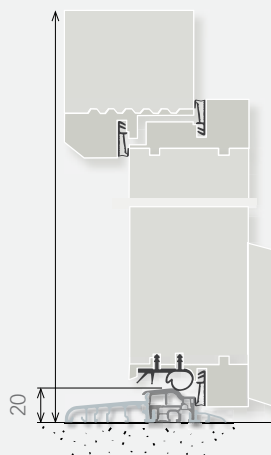

TH 80 - soglia termica 80
con profilo aggiuntivo esterno (ap. verso l'esterno)
*TH 80 - heat profile 80
with additional external profile (opens outwards)*

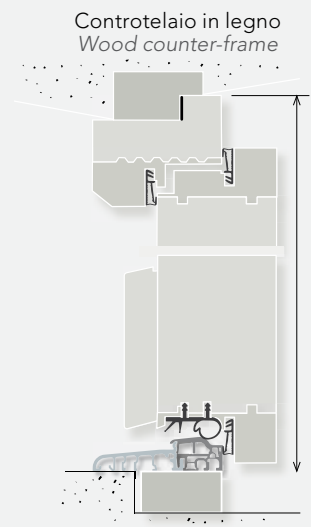

Controtelaio in legno
Wood counter-frame
TH 80 - soglia termica 80
con profilo di allargamento in legno
*TH 80 - heat profile 80
with wooden extension profile*

CHIUSURA MULTIPUNTO / MULTIPOINT LOCK

Chiusura multipunto con cilindro sagomato / Multipoint lock with profile cylinder

AS2300

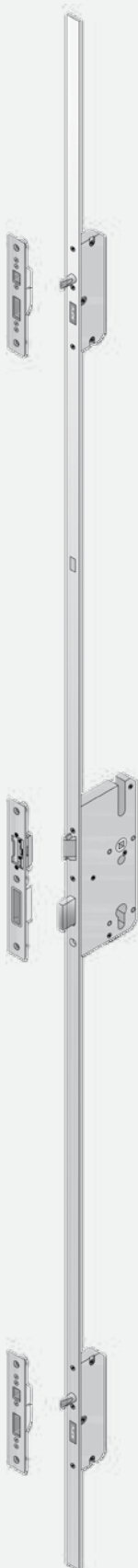

AS2600

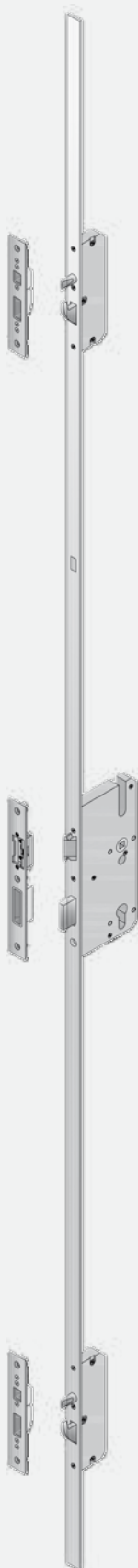

AS2600
con TSH
with TSH

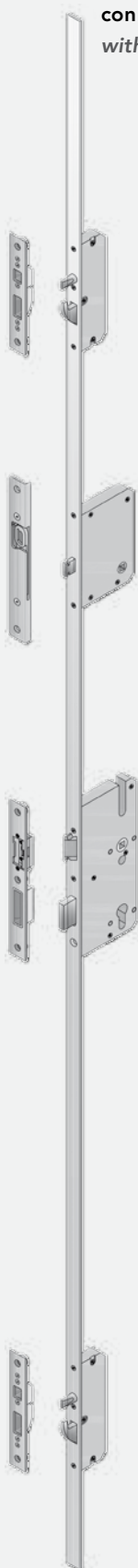

AS2608

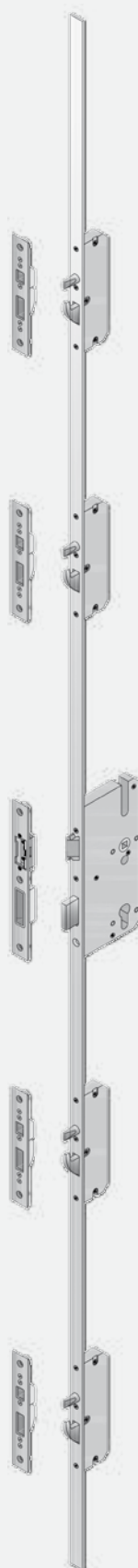

AS3600
autobloccante
self-locking



Attenzione:
autobloccante,
non combinabile
con un apriporta
elettrico.

Notice:
self-locking, cannot
be combined
with electric door
opener.

**GU Secury Automatic
con apriporta
automatico tipo A**

Su richiesta disponibile anche
con funzione antipanico
**with type A automatic
door opener**
Also available with panic bar,
on request



Attenzione:
autobloccante,
non combinabile
con un apriporta
elettrico.

Notice:
self-locking, cannot
be combined
with electric door
opener.

Mediator con cilindro sagomato

Mediator è in linea di principio la com-
binazione di una serratura autobloc-
cante per porte d'emergenza (funzione
antipanico) e un apriporta elettrico.

Mediator with profile cylinder

Mediator is basically the combination
of a self-locking door lock for emer-
gency doors (panic function) with an
electric door opener



**Tenuta antistrappo
Security hinges**



**Sistemi di sblocco
Door unlocking systems**



**Apriporta elettrico senza
funzione di arresto:**

La porta può essere aperta
solo quando l'apriporta
è alimentato con energia
elettrica.

**Electric door opener
without stop function:**
The door can be opened
only when the door ope-
ner is electrically wired.



**Apriporta elettrico con
funzione di arresto:**

Un impulso elettrico è
sufficiente per mantenere
l'apriporta sbloccato fino
all'apertura della porta.

**Electric door opener with
stop function:**
One electric pulse is
sufficient to keep the door
opener unlocked until the
door is opened.



**Sistema
di sblocco diurno
Daytime unlocking
system**

PORTONCINI DI SICUREZZA PER LA SVIZZERA SECURITY FRONT DOORS FOR SWITZERLAND



Profili telaio Frame profiles

Telaio a spigolo
Apertura: DIN sinistra
Sharp corner frame
Opens: DIN left

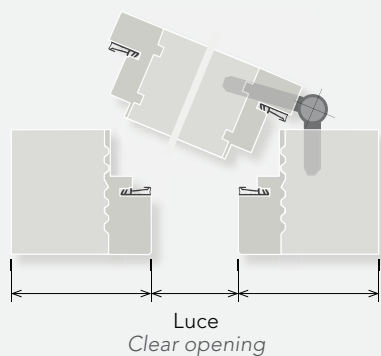

Soglie Thresholds

TH 100 - soglia termica 100
con profilo di allargamento
in legno
TH 100 - heat profile 100
with wooden extension profile

TH 120 - soglia termica 120
con profilo di allargamento
in legno
TH 120 - heat profile 120
with wooden extension profile

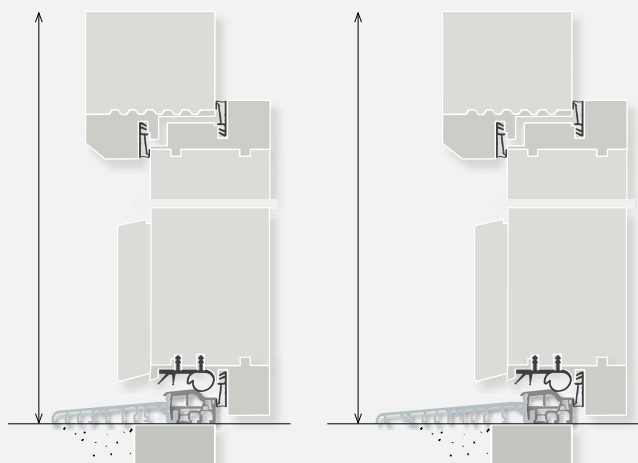



Chiusura multipunto con cilindro tondo
Multipoint lock with round cylinder

Mint 1893

Mint 18933 Combi

Mint 1895

Mint 18953 Combi

Mint SV 18945

Chiusura multipunto autobloccante, con funzione antipanico E
Self-locking multipoint door lock, with panic function E

GU Security Automatic con apriporta automatico tipo A

Su richiesta disponibile anche con funzione antipanico
with type A automatic door opener, Also available with panic bar, on request

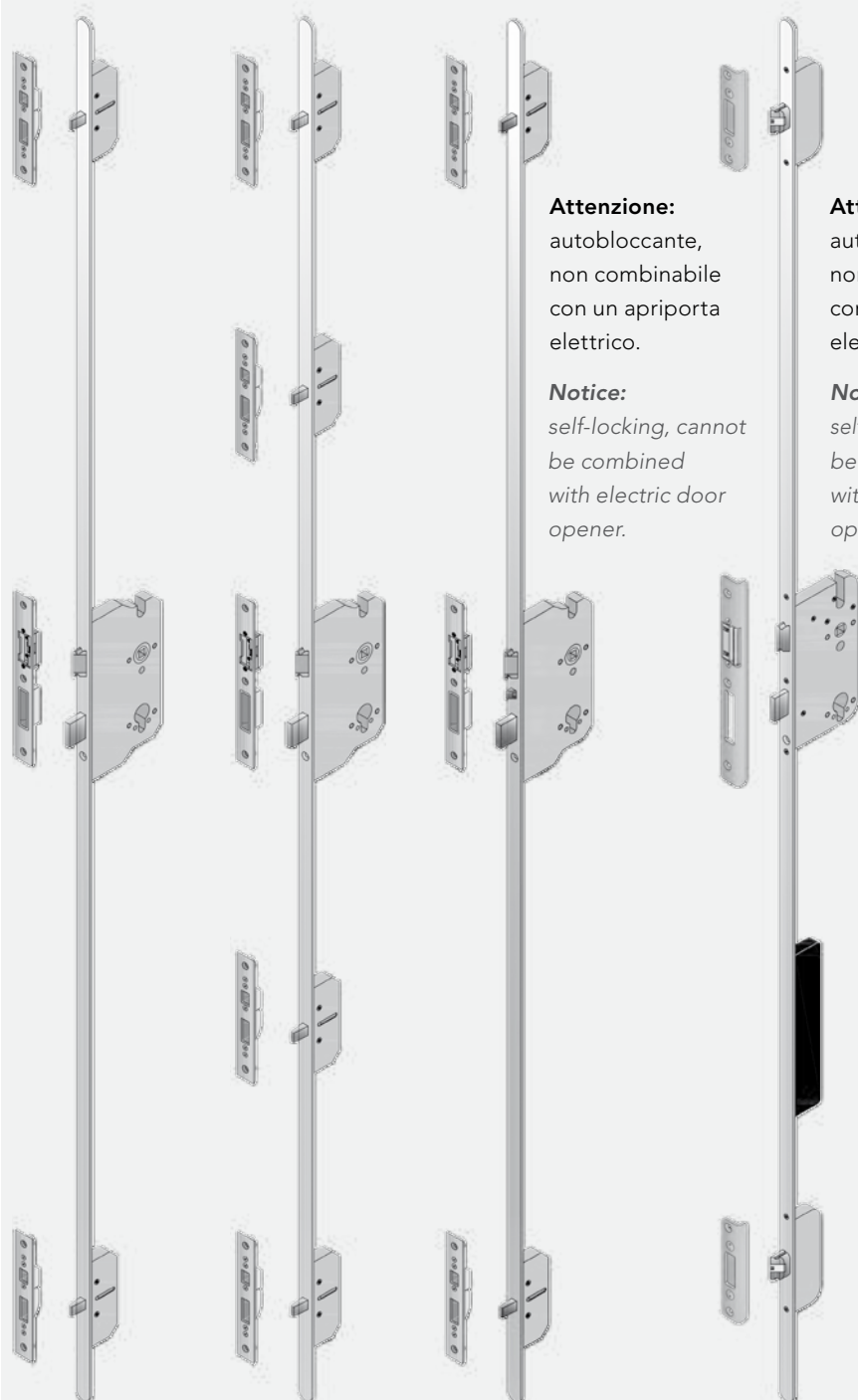

Attenzione:
autobloccante, non combinabile con un apriporta elettrico.

Notice:
self-locking, cannot be combined with electric door opener.

Attenzione:
autobloccante, non combinabile con un apriporta elettrico.

Notice:
self-locking, cannot be combined with electric door opener.

Sistemi di sblocco
Unlocking systems

Apriporta elettrico senza funzione di arresto: La porta può essere aperta solo quando l'apriporta è alimentato con energia elettrica.
Electric door opener without stop function: The door can be opened only when the door opener is electrically wired.



Apriporta elettrico con funzione di arresto: Un impulso elettrico è sufficiente per mantenere l'apriporta sbloccato fino all'apertura della porta.
Electric door opener with stop function: One electric pulse is sufficient to keep the door opener unlocked until the door is opened.



Sistema di sblocco diurno
Daytime unlocking system



SISTEMA DI CONTROLLO ACCESSI ELETTRONICO WIRELESS



Un sistema di chiusura multipunto intelligente dal futuro promettente. Disponibile solo come set completo.

Innovazione e comfort moderno

La serratura da infilare MINT SV assicura il massivo livello di sicurezza al vostro portoncino CasaClima che con l'intelligente sistema di chiusura multipunto rappresenta un punto di riferimento nel settore. Basta chiudere il portoncino e la serratura si blocca automaticamente in 4 punti, garantendo il livello di sicurezza riconosciuto dalle assicurazioni.

Dall'esterno la porta si apre con la chiave e ad ogni chiusura il portoncino si blocca automaticamente senza doverlo fare appositamente.

La funzione antipanico "E" assicura una grande praticità d'uso. Azionando la maniglia sul lato interno tutti gli scrocci si ritraggono e il portoncino si apre.

Disponibile con cilindro sagomato e cilindro tondo

Il portoncino CasaClima con sistema di controllo accessi elettronico wireless può essere integrato a scelta con i due componenti di seguito indicati.

E-Access, meccanismo di sicurezza elettronico in combinazione con la serratura Mint SV.

Un meccanismo di sicurezza con tecnologia RFID consente l'accesso keyless. È possibile assegnare o cancellare in qualsiasi momento i diritti di accesso utilizzando le schede di programmazione + e -. Anche in questo caso non è necessario cablare il portoncino d'ingresso. Il meccanismo di sicurezza è alimentato con comuni batterie da 1,5V.

Installando un modulo di trasmissione radio è possibile collegare il meccanismo a un citofono per consentire di aprire il portoncino in qualsiasi momento tramite l'impianto citofonico.



Un'ulteriore opzione è data dall'accesso senza chiavi o con altri mezzi.

Con il tastierino a codice numerico e-Access è possibile assegnare o cancellare in qualsiasi momento il proprio codice personale con la scheda +. Il lettore a parete attiva il meccanismo se il codice è stato immesso correttamente, potendo così aprire il portoncino azionando la maniglia. Non è necessario cablare il lettore né posare cavi tra il portoncino e il tastierino. Questa soluzione completa in modo ideale il sistema di controllo accessi keyless del vostro portoncino d'ingresso. Inoltre, a seconda delle richieste, è possibile integrare nel sistema di controllo accessi anche altre porte.



SISTEMI DI CHIUSURA ELETTRONICI ELECTRONIC LOCKING SYSTEMS



Impronta digitale
Finger scanner



Tastierino numerico
Numeric keypad



Portoncino modello H108
con elemento laterale S1
a Merano - Alto Adige
*Front door model H108
with side element S1
in Merano - South Tyrol*

Aprirete il vostro portoncino in legno Rubner agevolmente e in modo sicuro

Sicurezza con il massimo comfort

L'apertura è pratica e avviene in automatico mediante il sistema di riconoscimento biometrico o il tastierino numerico. (la chiusura manuale con chiave è comunque sempre possibile). La serratura elettrica motorizzata sposta i massicci catenacci. Chiudendo il portoncino Rubner, la porta si blocca automaticamente senza necessità di azionare la maniglia.

Funzione antipanico su richiesta
(sufficiente per RC2 - WK 2).

Chiavi perse o dimenticate? Problemi d'altri tempi!

Open your Rubner wood front door easily and safely

Security and maximum comfort

Practical opening system that is activated automatically via the biometric authentication system or the numeric keypad. (manual locking with a key is anyhow always possible). The motor-driven electric lock moves the heavy bolts. When the Rubner front door is closed, it locks automatically without the need to use the handle.

Panic bar available on request
(sufficient for RC2 - WK 2).

Lost or forgotten keys? No longer a problem!

Impronta digitale - Tastierino numerico

Montaggio su pannello porta, telaio porta o muro casa

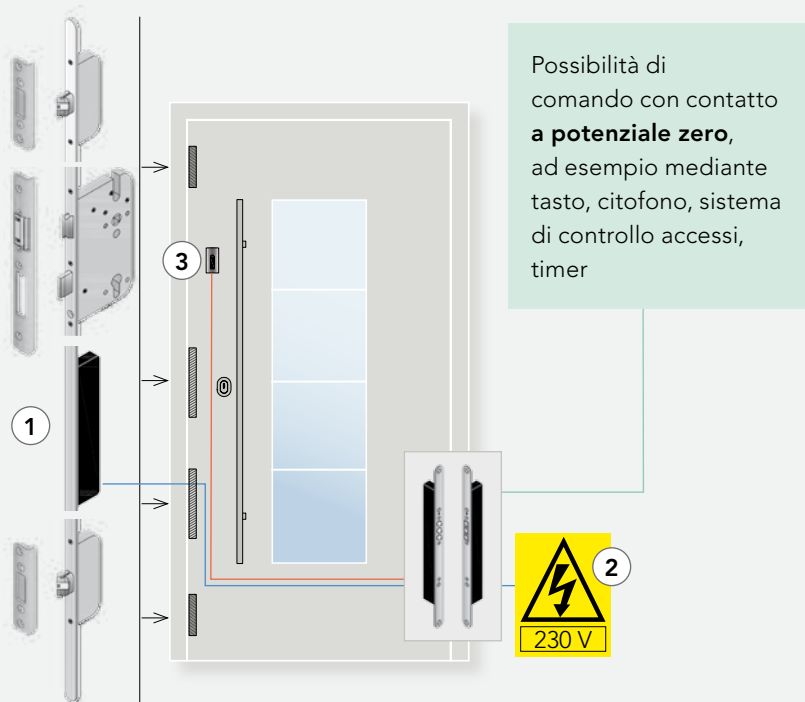

- 1 GU-Secury Automatic con apriporta automatico tipo A
- 2 Trasferimento wireless di energia elettrica e dati con SECURE connect 200
- 3 Comando tramite impronta digitale o tastierino numerico

Serratura motorizzata con trasferimento wireless

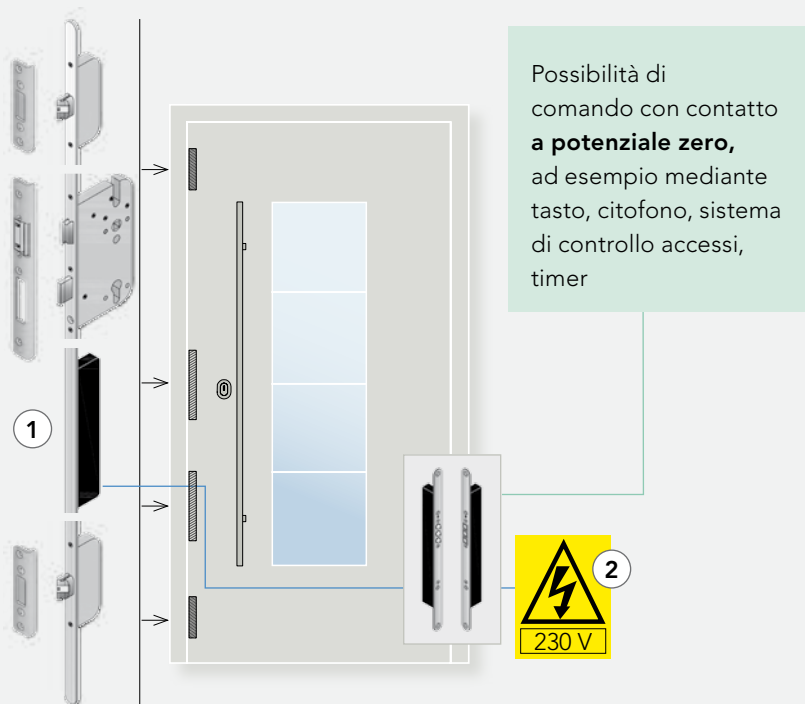

- 1 GU-Secury Automatic con apriporta automatico tipo A
- 2 Trasferimento wireless di energia elettrica e dati con SECURE connect 50



SECURE connect



WD-40
Spray detergente

Per eliminare i depositi di polvere consigliamo di utilizzare il detergente WD-40

Istruzioni di montaggio: Impronta digitale - Tastierino numerico

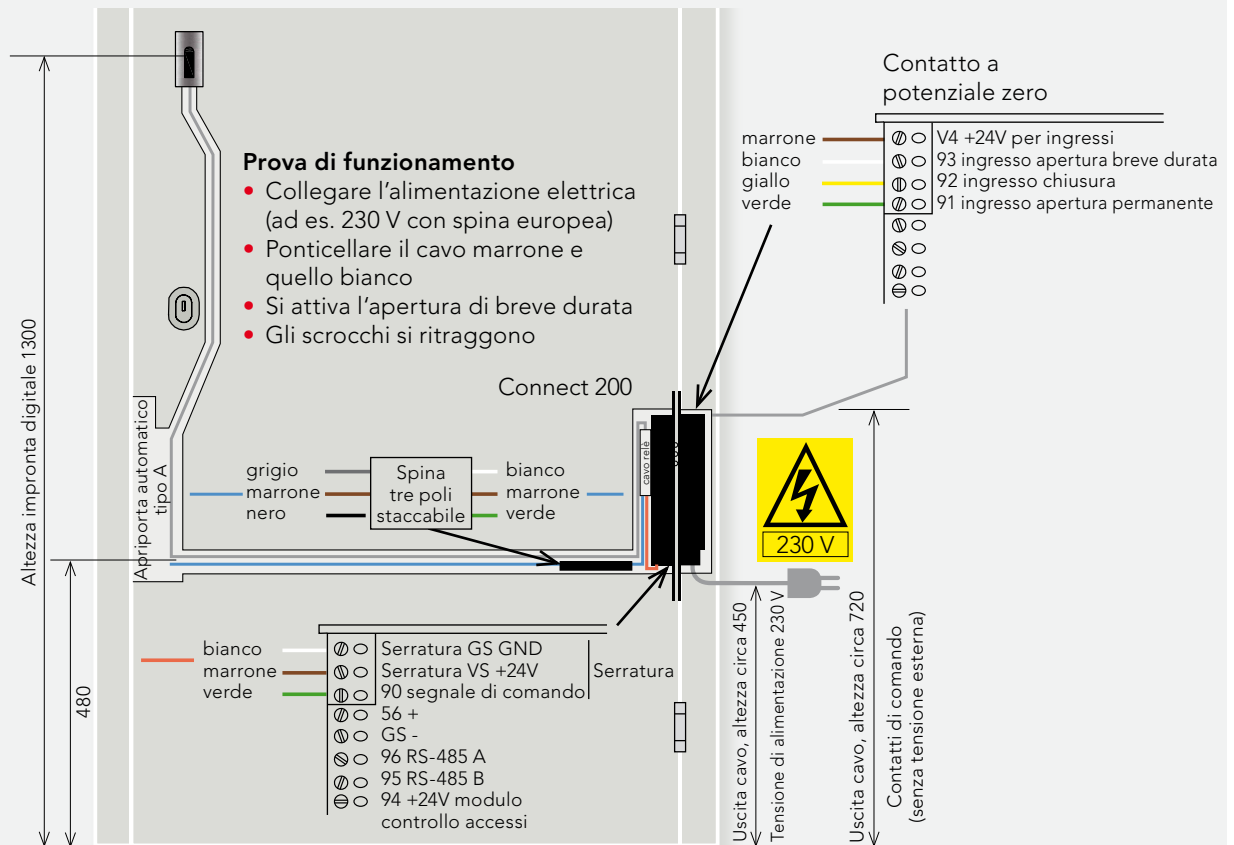

Istruzioni di vantaggio: serratura motorizzata con trasferimento wireless

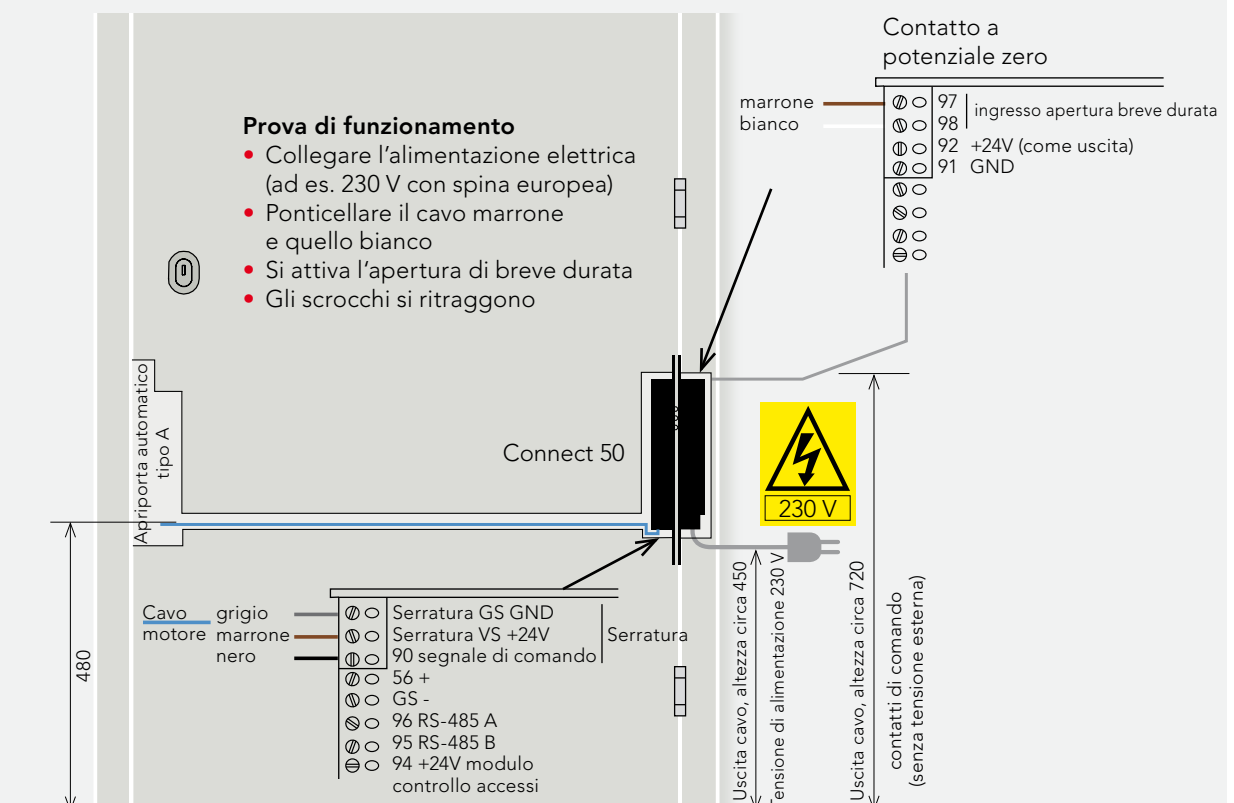

PROGETTARE CON LEGNO E COLORI

Tanti buoni motivi per scegliere
la nuova collezione colori

- **Velature bicomponente di altissima durata**
- Alta resistenza meccanica (ad es. chicchi di grandine, graffi)
- Resistenti alle creme e all'unto
- Traspiranti
- La superficie resta elastica
- Ottima resistenza ai raggi UV
- Durata nettamente superiore sul rovere

Oltre 1000 varianti
cromatiche

- Oltre ai colori RAL e NCS classici è possibile anche optare per pitture metallizzate o vernici opache con finitura strutturata



101 Rovere chiaro
Light oak



104 Rovere chiaro spazzolato
Light oak brushed



107 Frassino chiaro
Light ash



102 Rovere medio
Medium oak



105 Rovere medio spazzolato
Medium oak brushed



108 Frassino medio
Medium ash

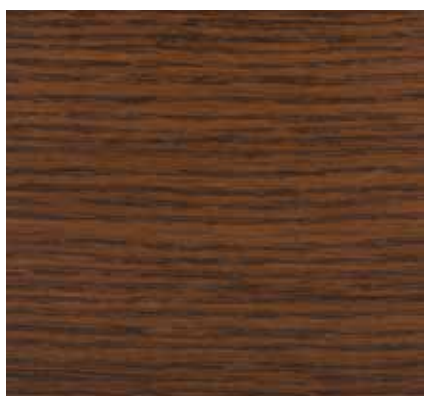

103 Rovere scuro
Dark oak



106 Rovere scuro spazzolato
Dark oak brushed

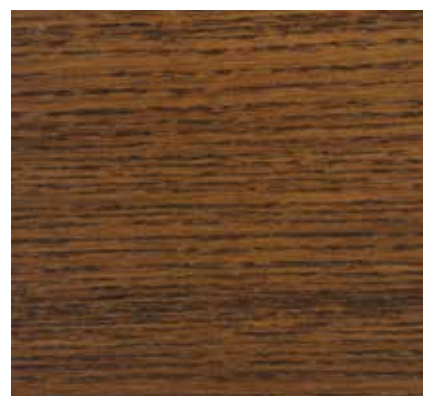

109 Frassino scuro
Dark ash

Tutti i campioni colore classici e con finitura strutturata servono da guida per orientarsi nella scelta. I risultati potrebbero variare a seconda delle essenze legnose, del tipo di levigatura, di posa e/o delle vernici impiegate. Altri colori disponibili su richiesta.

DESIGNING WITH WOOD AND COLOURS

Lots of good reasons for choosing the new collection of colours

- **Very long-lasting bicomponent paints**
- Very high resistance to mechanical stress (e.g.: hail, scratches)
- Surface resistant to unguents and greases
- Breathable
- Surface remains elastic
- Excellent resistance to UV rays
- Significantly more resistant on oak

Oltre 1000 varianti cromatiche

- In addition to the traditional RAL and NCS colours, it is possible to choose metallised colours or satin-finish and structuring paints



110 Larice chiaro
Light larch



113 Abete scuro
Dark fir

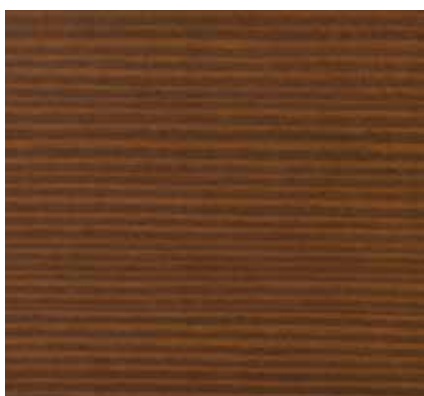

111 Larice scuro
Dark larch



114 Abete anticato con nodi spazzolato
Brushed ancient fir with knots



112 Abete chiaro
Light fir



115 Mogano
Mahogany



Colori RAL classici
Traditional RAL colours



Colori NCS
NCS colours



Colori RAL metallizzati
Metallised RAL colours

All classical and structured-finish colour samples are provided as a selection guide. Results may change according to the type of wood, the type of polishing and installation chosen and/or the paint used. Other colours are available on request.

VETRI / GLAZING

Vetro isolante doppio

- VSG 6 mm su entrambi i lati possibile solo per la versione con lastra satinata bianca e float trasparente
- VSG 6 mm/16/6 mm VSG
- Coefficiente Ug: 1,1 W/m²K

Double glazing

- Both panes VSG 6 mm available only for version with white satin finish pane and clear float
- VSG 6 mm/16/6 mm VSG
- Ug value: 1.1 W/m²K

Vetro isolante triplo

- Lastra esterna, VSG 6 mm float trasparente; lastra centrale, vetro ornamentale; lastra interna, VSG 6 mm float trasparente
- Coefficiente Ug: 0,9 - 0,5 W/m²K

Triple glazing

- External pane, VSG 6 mm clear float; central pane, ornamental glass; internal pane, VSG 6 mm clear float
- Ug value: 0.9 - 0.5 W/m²K

Vetro isolante triplo RC2

- Lastra esterna, P4A 9,5 mm float trasparente; lastra centrale, vetro ornamentale; lastra interna, VSG 6 mm float trasparente
- Coefficiente Ug: 0,9 - 0,5 W/m²K

RC2 triple glazing

- External pane, P4A 9.5 mm clear float; central pane, ornamental glass; internal pane, VSG 6 mm clear float
- Ug value: 0.9 - 0.5 W/m²K



Satinato



Silki



Uadi



Madras kyoto



Basic



Madras linea



Pavé

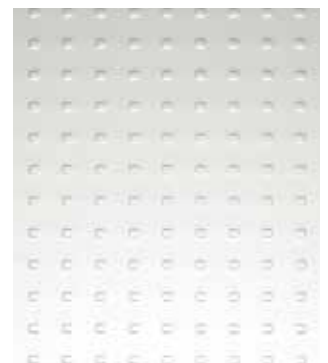

Mastercarré



Chinchilla



Barock



Kathedral



Delta



Ornament 504



Adk bianco / white

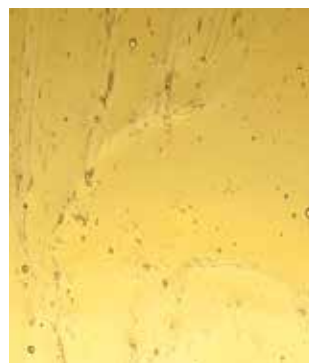

Adk giallo / yellow



Adk bronzo / bronze



Madras bianco/white



Madras blu / blue



Madras bronzo / bronze



Vetro al piombo / Lead glass



Vetro al piombo: progettazione individuale / Lead glass: personal design



Sfaccettatura / Facetting



Satinato trasparente, striato
Satin finish with clear stripes



Dettaglio
Detail



Satinato con bordo smaltato
Satin finish with enamelled glass



Dettaglio
Detail

MANIGLIONI / PUSH HANDLES



Tondo, acciaio inox

- 800/500/350 mm
- disponibile in tutte le lunghezze

Rounded, stainless steel

- 800/500/350 mm
- available in all lengths

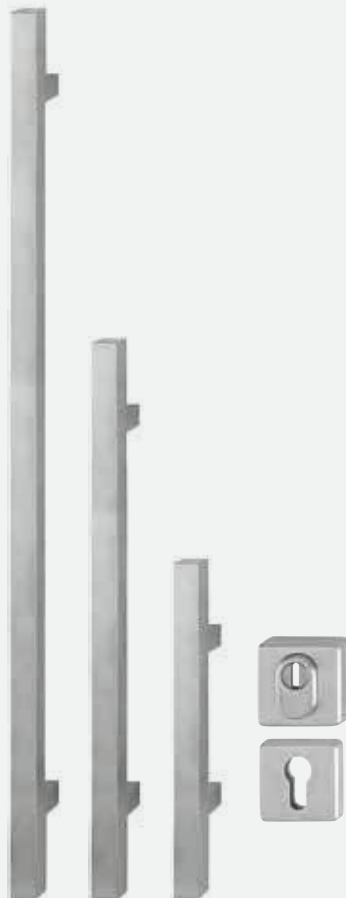

Squadrato, acciaio inox

- 800/500/350 mm
- disponibile in tutte le lunghezze

Squared, stainless steel

- 800/500/350 mm
- available in all lengths



Maniglione in legno, supporto in acciaio inox

- disponibile in tutte le lunghezze e in tutte le essenze legnose

Wooden push handle with stainless steel bracket

- available in all lengths and in all wood types



Modello H108 / Model H108



Modello Legno vecchio 1 / Model Old wood 1



Modello H132 / Model H132



Squadrato, ferro battuto

- solo 1000 o 800 mm

Squared, wrought iron

- 1000 or 800 mm only



Modello H138 / Model H138



Maniglione squadrato, metallo nero RAL 9005 lucido

- solo 800 mm

Squared push handle, black metal glossy RAL 9005

- 800 mm only



Modello H139 / Model H139



Maniglione semicircolare

- acciaio inox

Semicircular push handle

- stainless steel



Maniglione ad angolo

- acciaio inox

Angled push handle

- stainless steel



Flesso

- acciaio inox
- stainless steel



Maniglione quadro

- acciaio inox

Square push handle

- stainless steel

MANIGLIE / HANDLES

Versioni in acciaio inox
Stainless steel versions



Arena -R

- acciaio inox / stainless steel



Cintre-R

- acciaio inox / stainless steel



Zoe-R

- acciaio inox / stainless steel



Patrik II-R

- acciaio inox / stainless steel



Ronny II-R

- acciaio inox / stainless steel



Cintre Squaere-R

- acciaio inox / stainless steel



Ronny Squaere-R

- acciaio inox / stainless steel



Galina II Squaere-R

- acciaio inox / stainless steel



Pomolo

- acciaio inox

Knob

- stainless steel



Rosetta di sicurezza sporgente, con sicura antiestrazione

- quadrata o tonda
- acciaio inox
- versione PZ (per cilindro profilato)
- versione RZ (per cilindro tondo)

Raised safety washer, with anti-extraction ring,

- squared or round
- stainless steel
- PZ version (for profiled cylinder)
- RZ version (for round cylinder)



Rosetta di sicurezza Piano montata a raso, con sicura antiestrazione

- quadrata o tonda
- acciaio inox
- versione PZ (per cilindro profilato)

Plano safety washer flush-mounted, with anti-extraction ring

- squared or round
- stainless steel
- PZ version (for profiled cylinder)



Maniglia di sicurezza con placca esterna e maniglia con placca interna

- acciaio inox
- ottone lucido

Safety handle with external plate and handle with internal plate

- stainless steel
- polished brass



Ferramenta di sicurezza uso misto con placca lunga all'esterno e maniglia su rosetta all'interno

- acciaio inox

Safety hardware for mixed use with long plate outside and handle on washer inside

- stainless steel

Versioni in ferro battuto
Wrought iron versions



Maniglia di sicurezza con pomolo Ehrenburg con sicura antiestrazione
• ferro battuto
Safety handle with Ehrenburg knob with anti-extraction ring
• wrought iron



Maniglia Ehrenburg con sicura antiestrazione
• ferro battuto
Ehrenburg handle with anti-extraction ring
• wrought iron



Maniglia con pomolo tondo, con sicura antiestrazione
• ferro battuto
Handle with round knob, with anti-extraction ring
• wrought iron



Maniglia con pomolo squadrato, con sicura antiestrazione
• ferro battuto
Handle with square knob, with anti-extraction ring
• wrought iron

ZOCCOLI IN LAMIERA
METAL SHEETING KICK PLATES



Versione liscia
Smooth version



Versione sporgente
Jutting version



Acciaio inox
Stainless steel



Bronzo
Bronze



Ottone
Brass



Nero RAL 9005
RAL 9005 Black

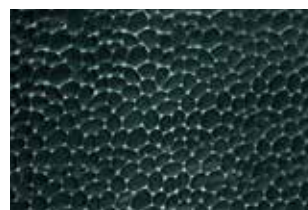

Ferro battuto
Wrought iron



Nero passivato
Black passivated finish

ACCESSORI ESCLUSIVI EXCLUSIVE ACCESSORIES

ChiUdiporta aereo Upper door opener



ChiUdiporta aereo a scomparsa
Hidden upper door opener

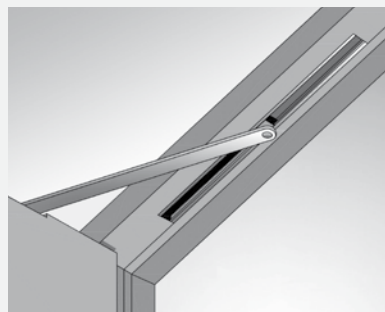

TS 3000
ChiUdiporta aereo
Upper door opener



TS 5000
ChiUdiporta aereo
Upper door opener

TS5000 L
Da montare sul lato opposto a
quello della cerniera
To be assembled on the side
opposite that of the hinge

Possibilità di montaggio modelli TS 3000 e TS 5000
Models TS 3000 and TS 5000 can be assembled

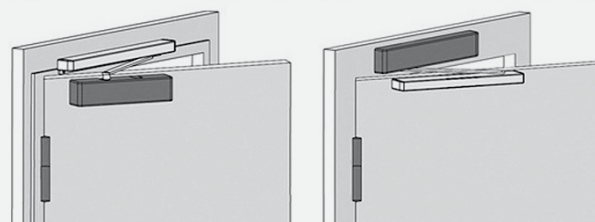
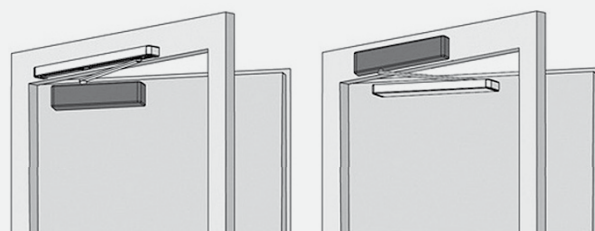

Spioncino porta Door peephole

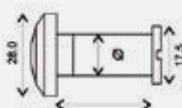

Spioncino porta
Door peephole



Spioncino digitale
Digital peephole

Nottolino per limitatore d'apertura porta Pawl for door limiter



Nottolino in acciaio inox per chiusura
multipunto con cilindro sagomato AS2600
con limitatore d'apertura porta TSH
Stainless steel pawl for multipoint lock
AS2600 with profile lock with TSH door limiter

Imbucalettere Mail slots



cromata / chrome-plated



bronzata / bronze-plated

1 Portoncino dal design moderno nei pressi di Stoccarda - Germania
Modern design front door near Stuttgart - Germany

Citofoni
Intercommunication systems



Citofono cromato con luce e pulsante
Intercom, chrome-plated with light and push-button



Citofono ottonato con luce e pulsante
Intercom, brass-plated with light and push-button

Cassette
Mailboxes

Esempio di cassetta in legno
Example of wooden mailbox



Battiporta
Door knocker

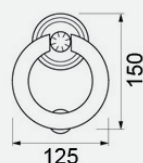

acciaio inox
stainless steel



OLTRE 30 ANNI DI SUCCESSO

Ogni uomo ha il suo particolare aspetto, vive, pensa e agisce individualmente, perché ognuno di noi è unico. Lo stesso vale per i nostri portoncini che sono unici e individuali, perché realizzati su misura, secondo le specifiche richieste della clientela. E tutto questo da oltre trent'anni. "È con orgoglio che possiamo guardare indietro alla movimentata storia di successo della nostra azienda nella produzione di portoncini", ha dichiarato Erich Fink, amministratore di Rubner Porte dello stabilimento del Renon.

Con pochi collaboratori Rubner Porte di Renon in Alto Adige è riuscita a diventare un importante produttore di portoncini in legno. Il direttore di produzione Max Steiner (in pensione dal 2011) e il suo team di artigiani impegnati, la maggior parte dei quali lavora ancora in azienda, hanno dato tanto all'azienda, contribuendo in misura sostanziale al suo successo. L'area di vendita si estende ormai da molti anni ben oltre i confini provinciali e ogni anno vengono consegnati circa 4.500 portoncini in legno sui mercati internazionali.

1984

Avvio della produzione di portoncini nello stabilimento di Renon. L'azienda artigianale, facente parte del gruppo Rubner operante a livello europeo, si specializza nella produzione di portoncini in legno. I cinque modelli di design H2, H5, H6, H8 e H9 sono molto apprezzati. Oggi, circa trent'anni dopo, l'azienda Rubner Porte propone oltre 140 differenti portoncini di design, prodotti su misura per qualsiasi stile abitativo. Un successo che cresce continuamente, rimanendo sempre al passo con le moderne esigenze architettoniche.

1992

Dato l'aumento delle commesse, l'azienda amplia l'organico e il parco macchine. A questo si aggiunge inoltre un secondo stabilimento di produzione, a Perca in Val Pusteria, oggi diretto da Andreas Innerhofer, nei cui capannoni viene avviata la produzione di portoncini in legno di alta qualità. In collaborazione con l'istituto PfB di Rosenheim - centro di prove sui materiali da costruzione, rinomato a livello internazionale - vengono verificati e testati per la prima volta i portoncini di Rubner. Si aprono nuovi sbocchi commerciali nei paesi esteri confinanti. Le sempre maggiori richieste di portoncini dal look moderno e lineare portano allo sviluppo della nuova linea "Quarda", un design che ha fatto scuola.

2002

Il tema del risparmio energetico guadagna sempre più piede nel settore edile. Le norme edilizie come quelle relative agli standard CasaClima, Passivhaus e Minergie portano alla creazione di tecniche di produzione assolutamente nuove con il risultato di definire standard qualitativi ancora più elevati. L'idoneità dei prodotti in termini di protezione antincendio e acustica, tenuta alla pioggia battente e all'aria e resistenza antieffrazione sono valutati e testati da istituti di prove di fama internazionale. I portoncini Rubner superano egregiamente le prove, cosa attestata da numerose certificazioni. Il design diventa ancora più elegante e innovativo.

2012

Design e sostenibilità sono i temi dominanti. Nascono le linee di portoncini PROTECTA e PROTECTA DESIGN, realizzati con un mix di materiali, formato da legno e pannelli esteriori, quale risposta al legno-alluminio. Quasi contemporaneamente viene presentato il nuovo progetto di portoncini in LEGNO VECCHIO. L'utilizzo di legno vecchio, in combinazione con l'acciaio moderno e il vetro, sono le caratteristiche distintive di questo innovativo prodotto di design che trova grande riscontro alle fiere internazionali sull'edilizia. Grazie agli innovativi sistemi di chiusura elettronici dotati di sistema Fingerscan o tastierino numerico ma anche allo spioncino digitale, i portoncini Rubner offrono tecnologia all'avanguardia e un look individuale. Un portoncino che non è da tutti.

I portoncini Rubner oggi:

Rubner Porte è un punto di riferimento in molti paesi europei e sinonimo di qualità su misura in fatto di portoncini in legno.



APRIRE E CHIUDERE IL PORTONCINO PER DECENNI grazie alla collaUdata qualità Rubner

Il sig. Mayer di Collalbo in Alto Adige decide di farsi costruire nel 1985 un nuovo portoncino in legno per la sua casa e sceglie Rubner Porte. Ben 30 anni dopo il sig. Mayer conferma ancora l'eccezionale qualità del suo portoncino Rubner.



SICUREZZA E COMFORT grazie all'innovativo sistema di apertura Fingerscan

Entrare nella propria casa senza usare le chiavi e aumentare la sicurezza. Il dito si trasforma in una chiave. Appoggiandolo semplicemente sullo scanner montato all'esterno, il sistema di riconoscimento biometrico identifica la persona che si trova davanti al portoncino Rubner che si apre così automaticamente.

LE QUATTRO SEDI DI RUBNER PORTE

I nostri collaboratori sono il bene più prezioso dell'azienda e quindi il capitale più grande.

Rubner Porte è riconosciuta sui mercati internazionali come una delle principali aziende specializzate nella produzione di porte in legno. Circa 190 collaboratori lavorano per Rubner Porte nelle quattro sedi di Chienes, Perca, Belluno e Collalbo sul Renon.



1

1 Gita aziendale a Vienna

- 2 Stabilimento Chienes, produzione porte interne
- 3 Stabilimento Renon, produzione portoncini CasaClima
- 4 Stabilimento Belluno, produzione porte interne
- 5 Stabilimento Perca, produzione portoncini CasaClima



2



Ogni porta un pezzo unico

La scelta di materiali pregiati e il legno come versatile materia prima dalle naturali mazzature rendono ciascuna delle nostre porte un pezzo esclusivo.



Innovazione tecnologica

La più moderna tecnologia e i processi innovativi di lavorazione garantiscono ad ogni porta Rubner la massima qualità, dalla realizzazione di elementi singoli fino a grandi progetti.



Amore per il dettaglio

Rubner punta su precisione tecnica e perfezione artigianale. La finitura delle superfici, così come la cura dei dettagli, viene effettuata a mano.



3



4



5



Servizio di consegna

Le porte Rubner vengono consegnate direttamente presso il cliente con i nostri mezzi aziendali ecologici (standard Euro 5).



Montaggio

Montatori specializzati si occupano, su richiesta, dell'installazione puntuale, perfetta e professionale delle vostre porte.



Servizio clienti

Gli esperti collaboratori Rubner del servizio esterno sono a vostra disposizione in qualsiasi momento.

LO SPECIALISTA DEL LEGNO PER LE ESIGENZE SPECIFICHE DEL SETTORE EDILE.

Tutto da un unico fornitore.
Rubner: realizzazione chiavi in mano
di case, case a schiera per l'edilizia
agevolata, case vacanze, ville,
ampliamenti di hotel, porte interne,
portoncini CasaClima, finestre ...

Tutti i prodotti Rubner soddisfano i più stringenti requisiti di qualità, dai segati ai montanti in legno lamellare per telai, dai pannelli in legno massiccio al legno lamellare o alle complesse strutture in legno lamellare, fino alle porte, alle finestre e alle villette a schiera chiavi in mano, alle ville mondane e ai grandi progetti in legno. Tutto è creato da un unico fornitore con tecniche innovative ed ecosostenibili.

THE WOOD SPECIALIST FOR INDIVIDUAL REQUIREMENTS IN THE CONSTRUCTION.

All from the same supplier.
Rubner: turn-key residential houses,
terraced houses for subsidised
housing, holiday homes, villas, hotel
extension, interior doors, ClimateHouse
front doors, windows, ...

All Rubner products are built to meet the most demanding quality requirements, from sawnwood to the glulam uprights for frames, from solid wood panels to glulam elements and complex structures, to the doors, the windows and the turn-key terraced houses, the villas and the large timber projects. Everything is created by a single supplier with innovative and environmentally sustainable techniques.



- 1 Rubner Haus, CasaClima A Standard
- 2 Rortoncino CasaClima Rubner, modello H133 con elemento laterale S1
- 3 Finestre Rubner
- 4 Porte interne Rubner

- 1 Rubner Haus, ClimateHouse A Standard
- 2 Rubner ClimateHouse front door, model H133 with side element S1
- 3 Rubner windows
- 4 Rubner internal doors



2 3



4

SCOPRIRE E TOCCARE CON MANO

Benvenuti nel mondo delle porte Rubner

Venite a scoprire l'intera gamma delle porte Rubner nei nostri due esclusivi showroom, dove potrete esaminare da vicino tutti i modelli e chiedere il consiglio di un nostro esperto per realizzare il sogno di avere una porta in legno su misura, proprio come la desiderate. Vi aspettiamo!

Rubner Mondo Porte Chienes

Rubner Türen S.p.A.

Zona Artigianale, 4
39030 Chienes, Italia
Tel.: +39 0474 563 222

Come arrivare

- Arrivando dal Nord: Autostrada del Brennero fino all'uscita Bressanone/ Val Pusteria – SS49 in direzione Brunico/ S.Candido – dopo Chienes al semaforo girare a destra per Casteldarne.
- Arrivando dal Sud: A4 fino a Verona – A22 Autostrada del Brennero fino all'uscita Bressanone/ Val Pusteria – SS49 in direzione Brunico/ S.Candido – dopo Chienes al semaforo girare a destra per Casteldarne.
- Arrivando da Lienz: B100/ SS49 Via Val Pusteria in direzione Bressanone/ Bolzano – prima di Chienes al semaforo girare a sinistra per Casteldarne.

Rubner Mondo Porte Bolzano

Kampillcenter

Via Innsbruck 25/D
39100 Bolzano, Italia
Tel.: +39 0471 970 967

Come arrivare

- Dall'uscita autostradale di Bolzano nord, prendete verso il centro, dopo circa 2 km, a destra.
- Dall'uscita autostradale di Bolzano sUd prendete verso il centro e, quindi, in direzione del Brennero, dopo circa 2 km, a sinistra.
- Dal centro, prendete in direzione dell'imbocco autostradale Bolzano nord, attraversate ponte Campiglio e, dopo circa 200 m, a sinistra.



Rubner Mondo Porte Chienes



EXPERIENCING AND TOUCHING

Welcome in the Rubner doors' world

You experience the complete world of the Rubner doors in two showrooms. Here you get the chance to examine every model carefully, to look for expert and to let become reality your idea from the ideal, wooden, made to measure door. Come to visit us!

Rubner Mondo Porte Chienes

Rubner Türen S.p.A.

Zona Artigianale, 4
39030 Chienes, Italia
Tel.: +39 0474 563 222

Arrival

- From the north: „Brennerautobahn“ until exit Bressanone/ Val Pusteria – SS49/ E 68 in direction Brunico/ S.Candido – after Chienes on traffic light turn right in direction Casteldarne.
- From the south: A4 until Verona - A22 „Autostrada del Brennero“ until exit Bressanone/ Val Pusteria – SS49 in direction Brunico/ S.Candido – after Chienes on traffic light turn right in direction Casteldarne.
- From Lienz: B100/ SS49 „Pustertalerstraße“ in direction Bolzano – before Chienes on traffic light turn left in direction Casteldarne

Rubner Mondo Porte Bolzano

Kampillcenter

Via Innsbruck 25/D
39100 Bolzano, Italia
Tel.: +39 0471 970 967

Arrival

- From Bolzano Nord motorway exit, follow signs from Bolzano centro: we are located approximately 2 km from the exit on the right
- From Bolzano SUd motorway exit, follow signs for Bolzano centro then for Brennero: we are located approximately 2 km from the exit on the left
- From the city centre, follow signs for Bolzano Nord motorway junction over the Kampiller bridge: we are located approximately 200 m along the road on the left.



Rubner Mondo Porte Bolzano



Settori di attività, portafoglio marchi e sedi aziendali
Business sectors, brand portfolio and company offices

INDUSTRIA DEL LEGNO WOOD INDUSTRY	STRUTTURE IN LEGNO WOOD STRUCTURES	GRANDI PROGETTI CHIAVI IN MANO LARGE TURN-KEY PROJECTS	CASE IN LEGNO WOOD HOMES	PORTE IN LEGNO WOOD DOORS
<p>rhi RUBNER</p> <p>Rohrbach a.d.Lafnitz (A) ▲ ■</p> <p>nordpan RUBNER</p> <p>Valdaora (I) ▲ ■</p> <p>Strassen (A) ▲</p>	<p>RUBNER holzbau</p> <p>Bressanone (I) ▲ ■</p> <p>Calitri (I) ▲ ■</p> <p>Carpenedolo (I) ▲ ■</p> <p>Ober-Grafendorf (A) ▲ ■</p> <p>Villach (A) ■</p> <p>Lyon (F) ■</p> <p>Augsburg (D) ■</p>	<p>RUBNER objektbau</p> <p>Brunico (I) ■</p>	<p>RUBNER haus</p> <p>Chienes (I) ▲ ■</p> <p>Sarentino (I) ▲</p> <p>Wiesing (A) ■</p> <p>Munich (D) ■</p> <p>holzius VOLLHOLZHAUS</p> <p>Prato allo Stelvio (I) ▲ ■</p>	<p>RUBNER porte</p> <p>Chienes (I) ▲ ■</p> <p>Renon (I) ▲ ■</p> <p>Perca (I) ▲</p> <p>Belluno (I) ▲</p>

- ▲ Stabilimento di produzione
Production facility
- Consulenza e vendita
Sales and Consultancy
- Sede centrale del Gruppo
Central Group Headquarters

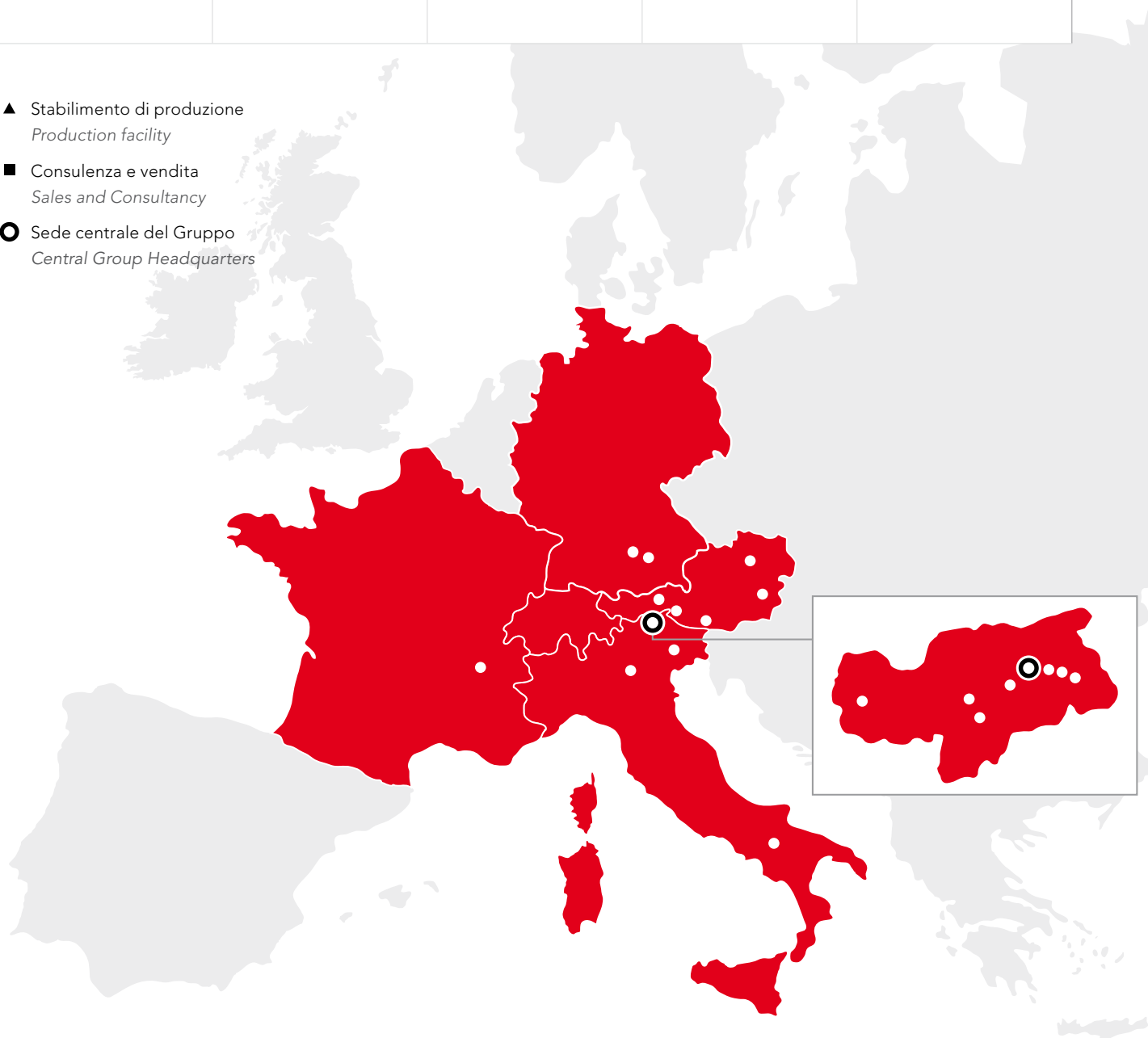

PASSIONE LEGNO

Il Gruppo Rubner opera in cinque settori di attività strategici: industria del legno, strutture in legno, grandi progetti chiavi in mano, case in legno e porte in legno. Proprio come in un'orchestra le singole aziende si fondono nel gruppo per dar vita a una sola grande unità e sviluppare appieno le proprie potenzialità. L'armonico scambio tra i singoli settori aziendali ha permesso a Rubner di raggiungere prestazioni d'eccellenza e di scalare il mercato, diventando lo specialista per antonomasia nel settore delle costruzioni in legno su misura. La filiera produttiva di Rubner ad integrazione verticale copre tutte le fasi del processo produttivo, dalla materia prima al progetto finito realizzato completamente in legno, e spazia dai segati ai montanti in legno lamellare per telai, dai pannelli in legno massiccio al legno lamellare o alle complesse strutture in legno lamellare, fino alle porte, alle finestre, alle case e ai grandi progetti in legno chiavi in mano.

PASSION FOR WOOD

The Rubner Group manages a business subdivided into five strategic sectors: wood industry, wood structures, large turn-key projects, wood homes and wood doors. Just as in an orchestra, the individual companies integrate in the Group to form a single great unit and fully develop their potentiality. The harmonious exchange between the various company sectors has allowed Rubner to reach the highest performance and to penetrate the market, becoming the specialist in the field of made-to-measure buildings in wood. The vertically integrated Rubner production range covers all the processes and operation phases, from raw materials to finished products. These products range from sawn wood to pillar layer frame glue laminated, from panels in solid wood to glulam components or complex glulam structures, to doors and windows and homes and to large turn-key projects, all manufactured by the Group with full respect for environmental sustainability and with advanced technical methods, so as to give life to customised projects and solutions.



Rubner Türen S.p.A.
Stabilimento Chienes
Zona Artigianale, 10
39030 Chienes, Italia
Tel.: +39 0474 563 222
Fax: +39 0474 563 100
tueren@rubner.com

Stabilimento Renon
Zona Artigianale, 13
39054 Renon/Collalbo, Italia
Tel.: +39 0471 356 118
Fax: +39 0471 356 636
ritten.tueren@rubner.com

www.porte.rubner.com

